

pdtools
SUPERABRASIVES



**PRODUCT
CATALOG**

Dear Clients,
PrJSC «POLTAVA DIAMOND TOOLS» has been manufacturing diamond and CBN tools for different industries since 1966.

Our specialists have researched & developed many solutions in various industries for the processing of hard-to-machine materials: from hard metal and superalloys to glass, stone and concrete.

This catalog includes resin, metal and vitrified grinding wheels and dressing rollers in the most popular shapes and dimensions. This is small part of the company's total assortment of more than 20,000 items.

Products are manufactured in different quality lines, each product of which is specially designed for its application.

PREMIUM is high performance quality line of diamond and CBN grinding wheels specially designed for use on CNC machines and grinders. PREMIUM grinding wheels have long life time, high surface quality and high performance.

EXPERT - resin bonded diamond and CBN grinding wheels for various applications in manufacturing processes for CNC and semi-automatic machines. Wheels of EXPERT line have increased performance, tool life and surface quality comparing with STANDARD resin bonds.









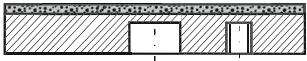
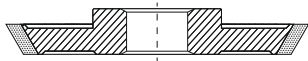
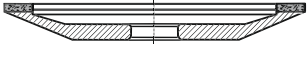
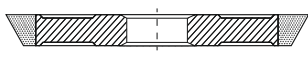
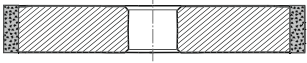
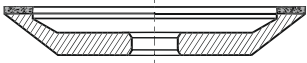
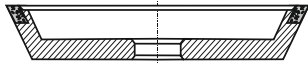

STANDARD resin, vitrified and metal bonded diamond and CBN grinding wheels are suitable for wide range of applications on various types of equipment. STANDARD wheels have high surface quality good tool life and good performance.

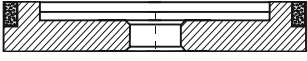
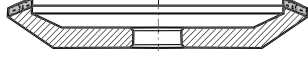
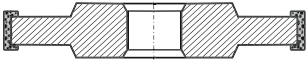
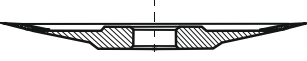
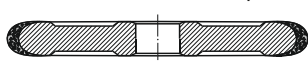
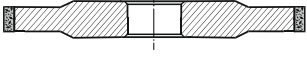
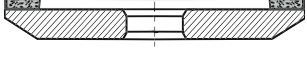
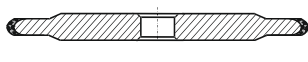
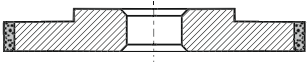
Thanks to innovative production technologies, we provide our customers with professional tools that provide clients maximum benefits. We guarantee the high quality of our products.

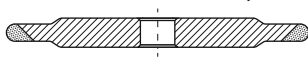
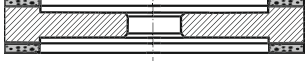
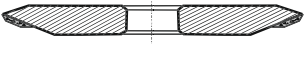

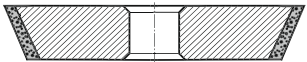
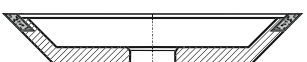
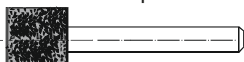
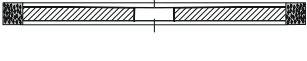
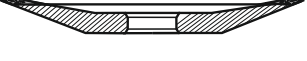

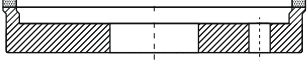
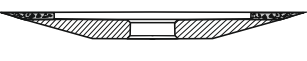

We look forward to cooperate with you!

pdtools
SUPERABRASIVES

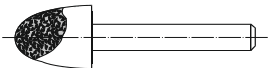
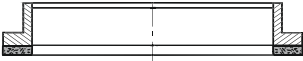
CONTENTS

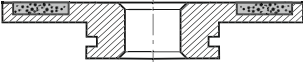
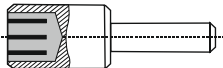
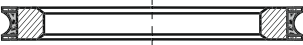
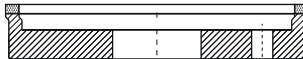
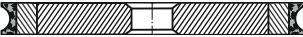
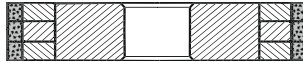
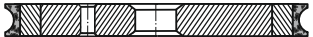
Item	p.	Item	p.	Item	p.
General information	6	6A2T Flat grinding wheels 	30	3V1 Conical grinding wheels 	36
Diamond and cbn grinding wheels for machine building, electronics, tool and woodworking industries	21	12A2-20 Dish grinding wheels 	30	1B1 Conical grinding wheels 	36
1A1 Straight grinding wheels 	22	12A2-45 Cup grinding wheels 	31	11V9-70 Cup grinding wheels 	37
1A1 Straight grinding wheels (compound) 	24	6A9 Recessed flat grinding wheels 	31	12V5-20 Dish grinding wheels 	37
14U1 Three-sided grinding wheels 	24	12V9-20 Dish grinding wheels 	32	1FF1 Flat grinding wheels with semicircular convex profile 	38
14A1 Straight flat grinding wheels 	25	4A2 Dish grinding wheels 	32	14FF1 Grinding wheels with semicircular convex profile 	39
3A1 Straight grinding wheels 	26	12V5-45 Cup grinding wheels 	33	14F1 Grinding wheels with semicircular convex profile 	39
9A3 Flat grinding wheels with double sided recess 	26	12D9 Dish grinding wheels 	34	A8 Straight diamond wheels (coreless) 	40
1V1 Grinding wheels 	27	12V9-45 Cup grinding wheels 	34	AW Cylindrical diamond mounted points 	40
1A1R Cut-off wheels 	28	12R4 Dish grinding wheels 	35	Diamond Honing Sticks 	41
6A2 Recessed flat grinding wheels 	29	4B2 Dish grinding wheels 	35	Diamond Honing Sticks (monolayer) 	41

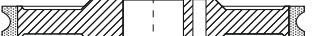
CONTENTS

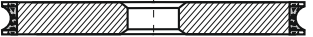
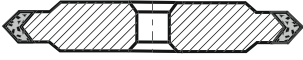
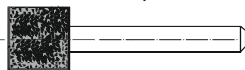
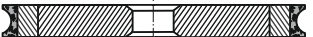
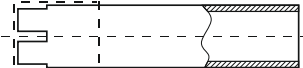
Item	p.	Item	p.	Item	p.
F1W Semicircular diamond mounted points 	42	2A2 Ring wheels 	49	Diamond profile dressing rollers	56
EW Conical diamond mounted points 	42	1A2 Flat grinding wheels 	49	Vitrified bonded CBN grinding wheels	59
Special diamond dressing sticks 	43	2F6V Flat grinding wheels with semicircular-concave profile 	50	6A2 Flat recessed diamond grinding wheels 	61
Diamond grinding wheels for machining of glass, crystal, diamonds, ceramics	44	1DD6V Diamond wheels for glass processing 	50	1A1 Straight grinding wheels 	62
1F6V Flat grinding wheels with semicircular-concave profile 	47	6A2 Flat recessed diamond grinding wheels 	51	A8 Straight diamond wheels (coreless) 	63
14F6V Flat grinding wheels with semicircular-concave profile 	47	1EE1 Flat grinding wheels with double-sided conical profile 	52	1E6Q Grinding wheels for thread grinding 	64
1F6V Flat grinding wheels with semicircular-concave profile 	48	14EE1 Flat grinding wheels with double-sided conical profile 	52	AW Cylindrical diamond mounted points 	64
1DD6V Diamond wheels for glass processing 	48	Diamond drills 	53	Diamond pastes	65

APPLICATION OF DIAMOND TOOLS AND THEIR ADVANTAGES OVER ABRASIVE TOOLS

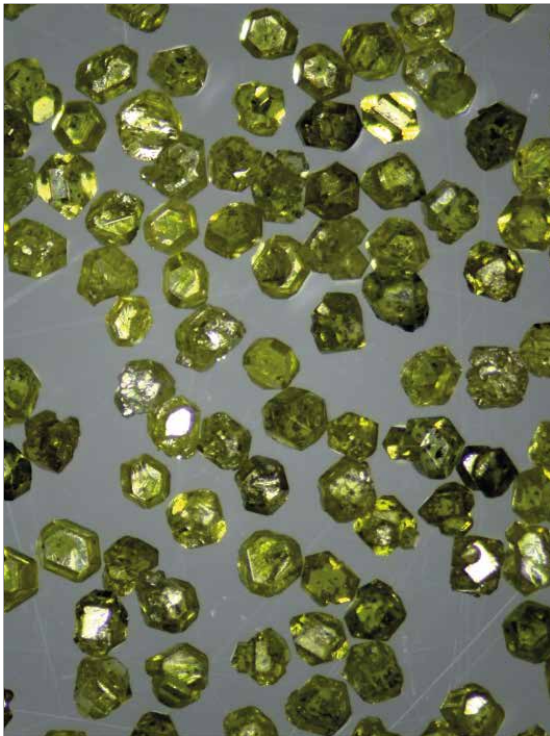

Applications of diamond tools

- Processing, sharpening and finishing of tools made of all alloy types. Sharpening and finishing of carbide tools. Processing and cutting of silicon, germanium and other semiconducting materials.
- Processing, cutting and finishing of tools made of ferrite, ceramic and glass materials.
- Processing of graphite and carbon rein-forced plastics. Processing and cutting of reinforced fiber glass plastics, fiberplastics.
- Finishing and polishing of precious stones.
- Cutting, finishing and polishing of artificial and natural stones.
- Processing of all types of decorative and technical glasses and porcelain. Cutting and processing of all types of refractory materials.

Advantages of diamond grinding tools over abrasive tools

- High wear resistance.
- Workpiece life longer after diamond tool profiling.
- Less thermal workpiece damage due to lower temperature in grinding zone. Longer lasting, hence reduced changeover times.
- Higher volumes at the same level of quality.

Physicomechanical characteristics of abrasive tool materials

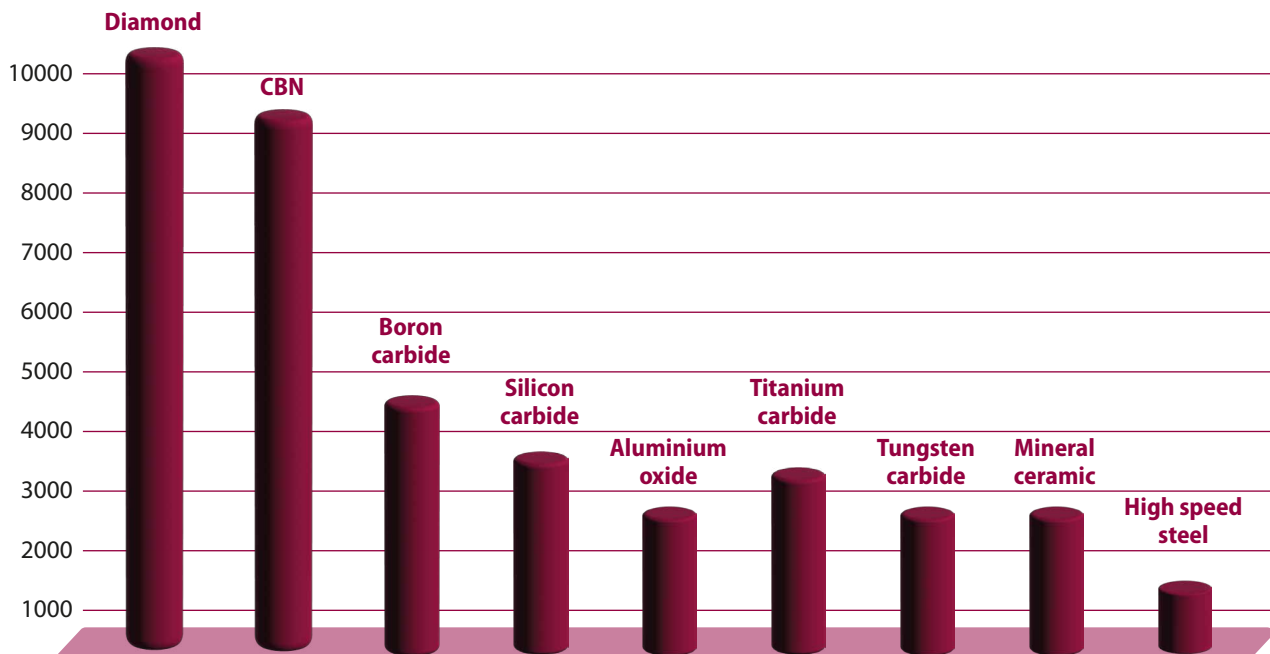

GRAIN OF DIAMOND AND CBN POWDER ACCORDING TO INTERNATIONAL STANDARDS

FEPA Diamond CBN	ANSI B74-16 USA	GRIT	Ukrainian Standard DSTU 3292-95	GRIT SIZE CLASS
µm	mesh	grit	µm	
D851/B851	20/25	25	800/630	SPECIAL USE
D711/B711	25/30	30		
D601/B601	30/35	35	630/500	
D501/B501	35/40	40	500/400	
D426/B426	40/45	45	400/315	
D356/B356	45/50	50		
D301/B301	50/60	55	315/250	EXTRA COARSE
D251/B251	60/70	60	200/160	
D213/B213	70/80	70		
D181/B181	80/100	80		
D151/B151	100/120	100	160/125	COARSE
D126/B126	120/140	140	125/100	
D107/B107	140/170	170	100/80	
D91/B91	170/200	200	80/63	
D76/B76	200/230	230		
D64/B64	230/270	270	63/50	MEDIUM
D54/B54	270/325	325	50/40	
D46/B46	325/400	400		
M63/B63	500	500	60/40	
M40/B40	550	550	40/28	FINE
M30/B30	500/600	600		
M25/B25	650	650	28/20	VERY FINE
M20/B20	1 100	1 000	20/14	
M16/B16	1 500	1 500	14/10	
M10/B10	2 000	1 700	10/7	EXTRA FINE
M6.3/B6.3	3 000	3 000	7/5	
M4.0/B4.0	5 000	4 000	5/3	
M2.5/B2.5	8 000	5 000	3/2	ULTRA FINE
M1.6/B1.6	12 000	10 000	2/1	
M1/B1	60 000	15 000	1/0	

FEPA - ISO 6106-2005 standard, issued according to FEPA (Federation of European Producers of Abrasives) recommendations.

MESH - ANSI b74.16 American standard.

GRIT SIZE CLASS - it is an indicative description that refers to precision grinding.

CONCENTRATION OF DIAMOND GRAIN IN THE DIAMOND LAYER

The concentration of diamond grain is the content by weight of diamond in the diamond layer. The unit of weight for diamond grain is a carat (ct), 1ct=0.2 g. The diamond concentration is one of the most important characteristics of a diamond tool, determining its cutting ability, productivity, length of usage and cost. The choice of concentration depends on the type of tool, the form and size of the working surface, the diamond grit size, the wear-resistance of the bond, and the conditions in which the tool will be used.

Diamond concentration by weight in the diamond layer

Diamond concentration	25%	50%	75%	100%	150%
Diamond weight in carats per 1 cm ³ of the diamond layer, (ct/cm ³)	1,1	2,2	3,3	4,4	6,6

Diamond content by volume in the diamond layer (%)

Diamond concentration weight	25%	50%	75%	100%	150%
Diamond volume in the diamond layer (%)	6,25	12,5	18,75	25,0	37,5

The following are guidelines for the choice of diamond concentration in the diamond layer:

- for a small contact surface between the grinding wheel and the workpiece, for example as in circular grinding, a high diamond concentration should be chosen. This provides higher wear resistance for the wheel, even at high loads.
- a large contact surface necessitates lowering the grinding temperature and the grinding intensity. In this case a lower diamond concentration should be used.

Wheels are produced with diamond concentrations of 25%, 50%, 75%, 100% and 150% (It is possible to produce wheels with other concentrations if needed by the customer.)

Low concentration of diamond grain

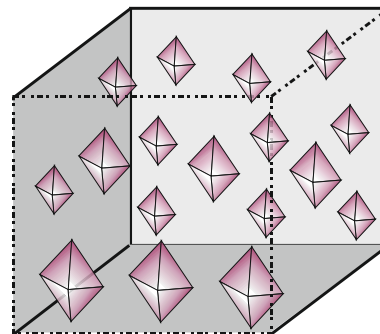

High concentration of diamond grain

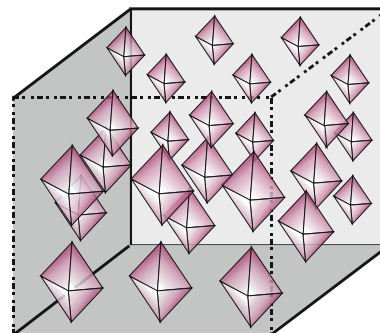

Grinding with and without coolant

Grinding with coolant is to be preferred, since the grinding wheel is subject to less wear and can be used under more demanding conditions, thus increasing grinding productivity. In addition, the probability of thermal damage to the workpiece (the appearance of burn marks) is reduced. Liquid coolants are recommended as coolants for diamond grinding wheels.

BOND TYPES FOR DIAMOND TOOLS

Resin Bond, Metal Bond, and Electroplated Diamond Tools

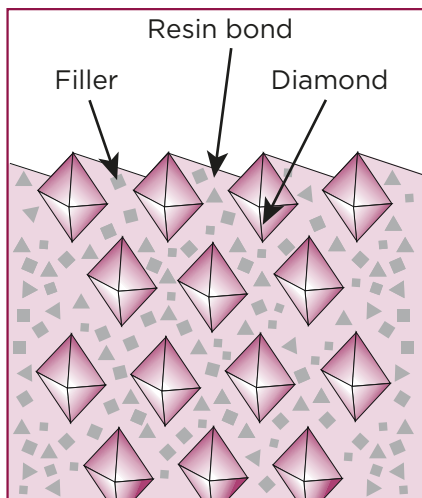

Resin bond

Structure of the diamond layer:

- Diamond.
- Resin bond.
- Filler.

Characteristics:

- Relatively low bond hardness.
- High removal productivity. Reduced work time.
- Low thermal conductivity and thermal stability.

Application:

Resin-bond wheels are used for fine and finishing operations, the fine sharpening and finishing of tungsten carbide cutting tools and superabrasive materials, and fine grinding and finishing of measuring and medical tools and workpieces of hard materials.

Grit size range:

D213 to D46 M63 to M6.3

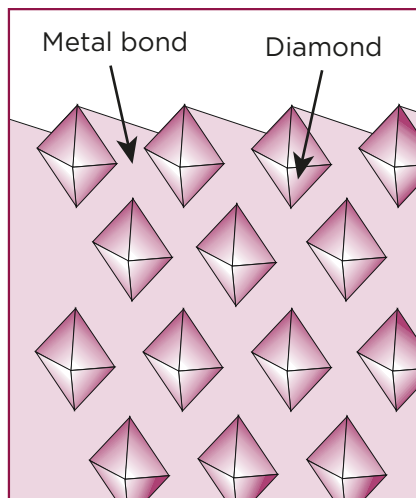

Metal bond

Structure of the diamond layer:

- Diamond.
- Metal bond.

Characteristics:

- High removal productivity.
- Significant bond hardness.
- Reduced work time.
- High thermal conductivity and thermal stability.

Application:

Metal bond wheels are used in preliminary operations that require the removal of material with relatively large tolerances, the sharpening of tungsten carbide tools, the grinding of tungsten carbide workpieces, profile grinding, cutting and grinding workpieces of specialty ceramics and hard to machine materials.

Grit size range:

D251 to D46 M63 to M6.3

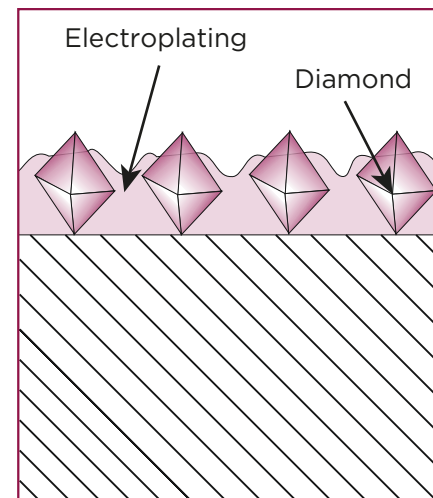

Electroplated

Structure of the diamond layer:

- Diamond.
- Electroplating.

Electroplated diamond wheels are characterized by a single or multiple-layer diamond and nickel coating on a supporting metal body. The separate diamond crystals are connected by a layer of nickel, the thickness of which is about 2/3 that of the grain. Thus the diamond is reliably fixed but protrudes well beyond the surface of the electroplating, thus allowing for the removal of shavings.

Characteristics:

- High cutting ability.
- Can be made in any shape..
- Relatively low cost.
- High thermal conductivity.

Application:

Electroplated wheels and tools are used for cutting and grinding silicon, germanium and other semiconductor materials, glass-ceramics, various types of technical glass, texturing of stone. Electroplated tools are widely used in the production of mounted diamond wheels and points, various forms of lapping tools, the production of hand tools for finishing tungsten carbide dies, die and alloy steels.

Grit size range:

D251 to D46 M63 to M30

CHOICE OF GRIT SIZES FOR WHEELS USED TO GRIND AND SHARPEN TUNGSTEN CARBIDE

Type of Bond	Recommended range of grit sizes	Roughness of workpiece surface, Ra, µm		
		For face grinding and sharpening	For flat grinding	For circular grinding
Resin bond				
Resin	D213-D107	0,63-0,16	1,0-0,32	1,0-0,32
	D91-D46	0,32-0,16	0,63-0,20	0,63-0,20
Resin (coated diamond)	D126-D46	0,32-0,10	0,63-0,16	0,80-0,20
Resin (non-coated diamond)	D126-M16	0,32-0,05	0,50-0,10	0,63-0,125
Metal bond				
Metal (high productivity)	D213-D126	1,0-0,32	1,25-0,63	1,25-0,63
	D107-D91	0,50-0,16	1,0-0,32	1,25-0,40
	D64-D46	0,32-0,16	0,63-0,16	0,63-0,32

BOND TYPES AVAILABLE FOR SUPERABRASIVE WHEELS AND TOOLS

Bond name	Product line	Recommendation for usage	Recommended grinding depth per 1 pass, mm
PREMIUM is high performance quality line of diamond and CBN grinding wheels specially designed for use on CNC machines and grinders. PREMIUM grinding wheels have long life time, high surface quality and high performance			
Resin bonds of Premium line for sharpening of tungsten carbide and steels on CNC grinders			
B9-00	PREMIUM	High-performance tool sharpening on all wheel shapes, mainly on CNC machines with coolant, mainly oil, but also works well with emulsion. The bond has sufficient edge resistance and performance / durability ratio.	0,06-0,15
B7-00	PREMIUM	High-performance tool sharpening on all wheel shapes, mainly on CNC machines with coolant, mainly oil, but also works well with emulsion. The bond has good edge resistance and higher lifetime than 89-00 bond.	0,06-0,15
Resin bonds of Premium line for tungsten carbide and HSS tools production on CNC grinders			
B6-02	PREMIUM	High-performance, wear and edge resistant bond for diamond with high demand of processed surface. Designed for wheels with angular and radial working layers. Has high cutting ability.	0,05-0,3
B6-04	PREMIUM	High-performance, wear and edge resistant bond for CBN with high demand of processed surface. Designed for wheels with angular and radial working layers. Has high cutting ability.	0,05-0,3
HSS01	PREMIUM	Used for sharpening and production of HSS saw blades for 14F1 CBN wheels. For CNC machines with coolant	
Resin bonds of Premium line for flat and cylindrical grinding of tungsten carbide and HSS on CNC grinders			
B1002	PREMIUM	For cylindrical and flat grinding of tungsten carbide and HSS with coolant for 1A1 and 14A1 wheels.	0,005-0,05
B1003	PREMIUM	For cylindrical and flat grinding of tungsten carbide and HSS with coolant for 1A1 and 14A1 wheels. Has better surface roughness and lifetime than B1002.	0,005-0,05

BOND TYPES AVAILABLE FOR SUPERABRASIVE WHEELS AND TOOLS

Bond name	Product line	Recommendation for usage	Recommended grinding depth per 1 pass, mm
Premium metal bonds for glass beveling and edge processing			
GI101	PREMIUM	GI101 bond is the solution for glass beveling and used on 6A2 shape. This bond has increased wheel life and grinding performance comparing with M2-01, M-300, M3-04 and other STANDARD metal bonds.	0,3-1,5
GI1 GI2 GI3 GI4	PREMIUM	GI201 bond is the solution for glass edging (flat, pencil, radius and other types) and used on 1F6V, 1DD6V shapes. This bond has increased wheel life and grinding performance comparing with M2-01, M-300, M3-04 and other STANDARD metal bonds.	0,3-1,5
EXPERT resin bonded diamond and CBN grinding wheels for various applications in manufacturing processes for CNC and semi-automatic machines. Wheels of EXPERT line have increased performance, tool life and surface quality comparing with STANDARD resin bonds.			
Diamond resin bonds of Expert product lines for processing tungsten carbide			
EXD1	EXPERT	Fine and finish grinding of tungsten carbide. Similar in operation with B1-13 and STD1 bonds, but has higher performance (30% higher than B1-13 bond and can work at higher grinding parameters). EXD1 has good edge retention and used with and without coolant. Lifetime is 1.5-2.5 times higher than B1-13 (the percentage of lifetime increase depends on specific grinding parameters).	0,02-0,1
EXD2	EXPERT	Soft fine and finish grinding of tungsten carbide. Similar in operation with B2-01 and STD2, but has higher performance (40% higher than B2-01 and can work at higher grinding parameters). EXD2 has the same softness, used with and without coolant. Lifetime is 2-3 times higher than B2-01 (the percentage of lifetime increase depends on specific grinding parameters).	0,02-0,08
CBN resin bonds of Expert product lines for processing hardened and alloyed steels			
EXB1	EXPERT	Fine and finish grinding of steels. Modernized and better modification of BN310 bond. It runs smoother and show 30% higher performance, can work at higher grinding parameter. Has lower temperature in grinding area and as consequence less burns. Can be used with and without coolant. Lifetime is higher by 40-60% than BN310 (the percentage of lifetime increase depends on specific grinding parameters).	0,02-0,06
EXB2	EXPERT	Fine and finish grinding of steels. Modernized and better modification of BN130 bond. Show 30% higher performance, can work at higher grinding parameters with sufficient edge resistance. Has lower temperature in grinding area and as consequence less burns. Can be used with and without coolant. Lifetime is 2-2,5 times higher than BN310 bond. Better applied for the wheels for face grinding.	0,02-0,06
EXB3	EXPERT	Fine and finish grinding of steels. Modernized and better modification of BN130 bond. Show 30% higher performance, can work at higher grinding parameters with sufficient edge resistance. Has lower temperature in grinding area and as consequence less burns. Can be used with and without coolant. Lifetime is 2-2,5 times higher than BN310 bond. Better applied for the wheels for radial grinding.	0,02-0,06

Bond name	Product line	Recommendation for usage	Recommended grinding depth per 1 pass, mm
STANDARD resin, vitrified and metal bonded diamond and CBN grinding wheels are suitable for wide range of applications on various types of equipment. STANDARD wheels have high surface quality good tool life and good performance.			
Diamond resin bonds of Standard product lines for processing tungsten carbide			
B2-01	STANDARD	Soft fine and finish grinding of tungsten carbide with and without coolant.	0,005-0,06
B1-13	STANDARD	Fine and finish grinding of tungsten carbide. In its composition there are special metal components which ensure better edge resistance than B2-01 bond. Used mainly with coolant, dry application is acceptable.	0,005-0,06
STD1	STANDARD	Fine and finish grinding of tungsten carbide. Modernized and better modification of B1-13 bond. Increased performance by 10%, can work at higher grinding parameters. Has the same hardness and edge resistance, used with and without coolant. Lifetime is higher by 20-30% than B1-13 bond (the percentage of lifetime increase depends on specific grinding parameters).	0,02-0,08
STD2	STANDARD	Soft fine and finish grinding of tungsten carbide. Modernized and better modification of B2-01 bond. Increased performance by 20%, can work at higher grinding parameters. Has the same softness, used with and without coolant. Lifetime is higher by 10-25% than B2-01 bond (the percentage of lifetime increase depends on specific grinding parameters).	0,02-0,07
CBN resin bonds of Standard product lines for processing hardened and alloyed steels			
BN130	STANDARD	Fine and finish grinding of steels with and without coolant.	0,02-0,04
BN 310	STANDARD	Fine and finish grinding of steels mainly with coolant. Has higher edge retention and lifetime than BN130.	0,02-0,04
CBN vitrified bonds for processing hardened and alloyed steels			
XBCK4 XBCK5 XBCL4 XBCL5	STANDARD	Universal vitrified bonds are developed for fine grinding and finishing of stainless and hardened steels in flat and round grinding operations. Bonds have the property of preventing burns and sufficient wear resistance. Bonds are well-renewal, have a dense structure. Recommended for steels with hardness higher than 55 HRC. To obtain the best surface finish, a grain concentration of 100% is recommended for flat grinding and a concentration of 125% - for round grinding.	0,02-0,1
VBCN5 VBCM5 VBCO5 VBSP5	STANDARD	Bonds are developed for fine grinding and finishing grinding of steels. The temperature in the grinding zone is low. Bonds have the property of preventing burns and high edge resistance. Recommended for steels up to 55 HRC. It is recommended to use a grain concentration of 125% to obtain the best surface finish. Tool life of wheels with these vitrified bonds can be 5 times longer than for resin bonded wheels.	0,02-0,01
VBBM5 VBBN5 VBBOS	STANDARD	Universal vitrified bonds are developed for fine grinding and finishing of stainless and hardened steels. The temperature in the grinding zone is low. Bonds have the property of preventing burns, enlarged pores and work softly. They are well-renewal during the application. It is recommended to use a grain concentration of 125% to obtain the best surface finish. Recommended for steels up to 60 HRC. Tool life of wheels with these bonds can be up to 5 times longer than for resin bonded wheels.	0,02-0,01

Bond name	Product line	Recommendation for usage	Recommended grinding depth per 1 pass, mm
Diamond metal bonds of Standard line for processing tungsten carbide and iron-containing alloys			
M1-01	STANDARD	Machining of tungsten carbide, tungsten carbide together with steel, heat-resistant steels, and titanium alloys under heavy grinding conditions.	1/5 of grain size
M2-01	STANDARD	Fiat, circular, internal, and longitudinal grinding of workpieces of hard non-metal materials-glass, ceramics, marble, granite, semiconducting materials-under normal grinding conditions.	
M2-02	STANDARD	Cutting of ceramics, glass, quartz, semiprecious stones and other non-metal materials. Harder and more wear-resistant than wheels using the M2-01 bond.	
M2-09	STANDARD	Grinding of titanium alloys, HSS, high-strength chilled, tempered cast irons.	
M-300	STANDARD	Machining of optical and technical glass. Higher removal rates than the M2-01 bond.	
M9-00	STANDARD	Processing of technical glass on mechanical feed lines.	
M3-00	STANDARD	Cutting of leuco-sapphire.	
M3-04	STANDARD	Machining of technical glass, crystal, semiconductors, ceramics, gemstones.	
M-310	STANDARD	Processing of technical glass and porcelain tile (ceramic granite tile).	
M3-08	STANDARD	Grinding and gem-cutting of natural diamonds.	
M3-10	STANDARD	Processing of brilliant girdle.	
M5-01	STANDARD	Honing of tempered and alloy steel.	
M5-04	STANDARD	Honing of steels and cast irons, finish honing of untempered steel, gray and alloyed cast irons.	
M5-05	STANDARD	Honing of alloyed steels, finish honing of tempered alloyed steels with a hardness of up to HRC 64.	
M5-06	STANDARD	Honing of gray and alloyed cast irons. Rough, fine, and finish honing of gray and alloyed cast irons with a hardness of HRC 40...50.	
M5-09	STANDARD	Machining of technical glass with mechanized feed. Higher removal rates than the M-300 bond.	

TOLERANCES FOR DIAMOND TOOLS

- for the hole diameter of A8 wheels..... H12
- for the hole diameter of other wheels..... H7
- for the outer diameter of 14EE1, 1EE1, 1FF1 wheels..... js14
- for the outer diameter of 14EE1, 1EE1, 1FF1 wheels..... js16
- linear measures up to 10 mm..... $\pm \frac{IT15}{2}$
- linear measurement higher than 10 mm..... $\pm \frac{IT14}{2}$

Tolerances for radial and axial run out of the working surfaces and the run out of the support surfaces of the wheels (except for A8 wheels) relative to the surface of the hole of the diamond wheel should be:

- For diameters up to 30 mm..... 8th degree of accuracy- GOST 24643
- For diameters greater than 30 mm..... 7th degree of accuracy- GOST 24643

Tolerances for the roundness of the outer surface of A8 wheels should correspond to the 9 degree of accuracy according to GOST 24643:

№	Outer diameter of A8 diamond wheels, mm	Roundness tolerances for the outer surface of A8 wheels
1	6...10	0,010
2	12...16	0,012
3	18...30	0,016
4	more than	0,020

WHEEL PARAMETERS

Parameters used in the catalogue are based on the FEPA standard for diamond tools:

- D** - top diameter
- E** - back thickness
- H** - hole diameter
- J** - hub diameter
- K** - inside diameter of flat
- L** - total stick length
- L1** - spindle length
- L2** - length of diamond layer
- R** - radius
- S** - face angle
- T** - wheel thickness
- T1** - reduced hub thickness
- U** - insert length
- V** - face angle
- W** - rim width
- X** - depth of diamond layer
- Y** - spindle diameter
- P** - depth of concavity of diamond layer

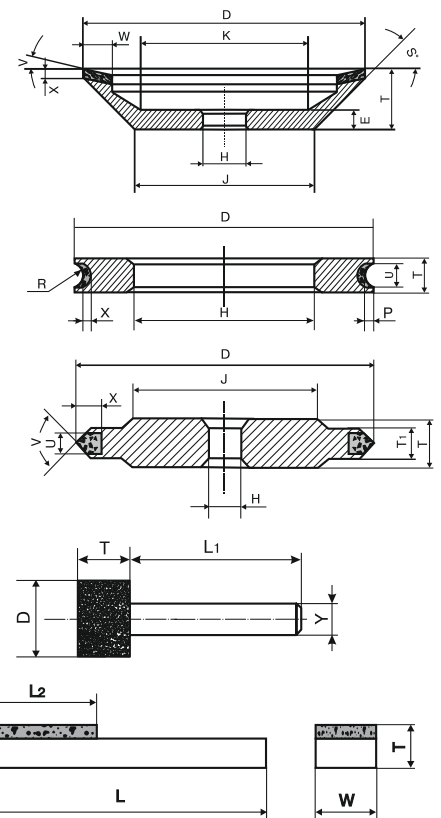

Shapes of diamond grinding wheels

Diamond grinding wheels described in the catalogue are based on the FEPA standard for diamond tools.

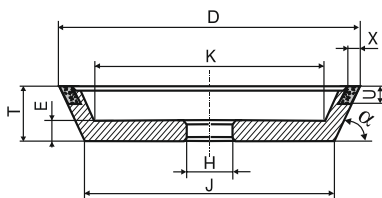

- designation of the shape of the wheel core
- designation of the shape of the diamond layer
- designation of the diamond layer location
- additional information/modification

11 V 9-70

Identification number for shapes of grinding wheel cores

- | | | |
|---|--|---|
| ① | | Flat wheel without recesses, $D/H \geq 1,8$ |
| ② | | Rim wheel, face wheel, $D/H < 1,8$ |
| ③ | | Flat wheel with one-sided relief |
| ④ | | Flat wheel with one-sided cone |
| ⑥ | | Flat wheel with one-sided recess |
| ⑨ | | Flat wheel with double-sided recess |
| ⑪ | | Cup wheel $45^\circ < \alpha < 90^\circ$ |
| ⑫ | | Dish wheel $\alpha \leq 45^\circ$ |
| ⑭ | | Flat wheel with double-sided relief |

**LETTERS DESIGNATING
THE SHAPE OF THE DIAMOND LAYER**

A		CH		G		M	
AH		D		H		Q	
B		E		K		U	
C		F		L		V	

Location of the diamond layer on the wheel core

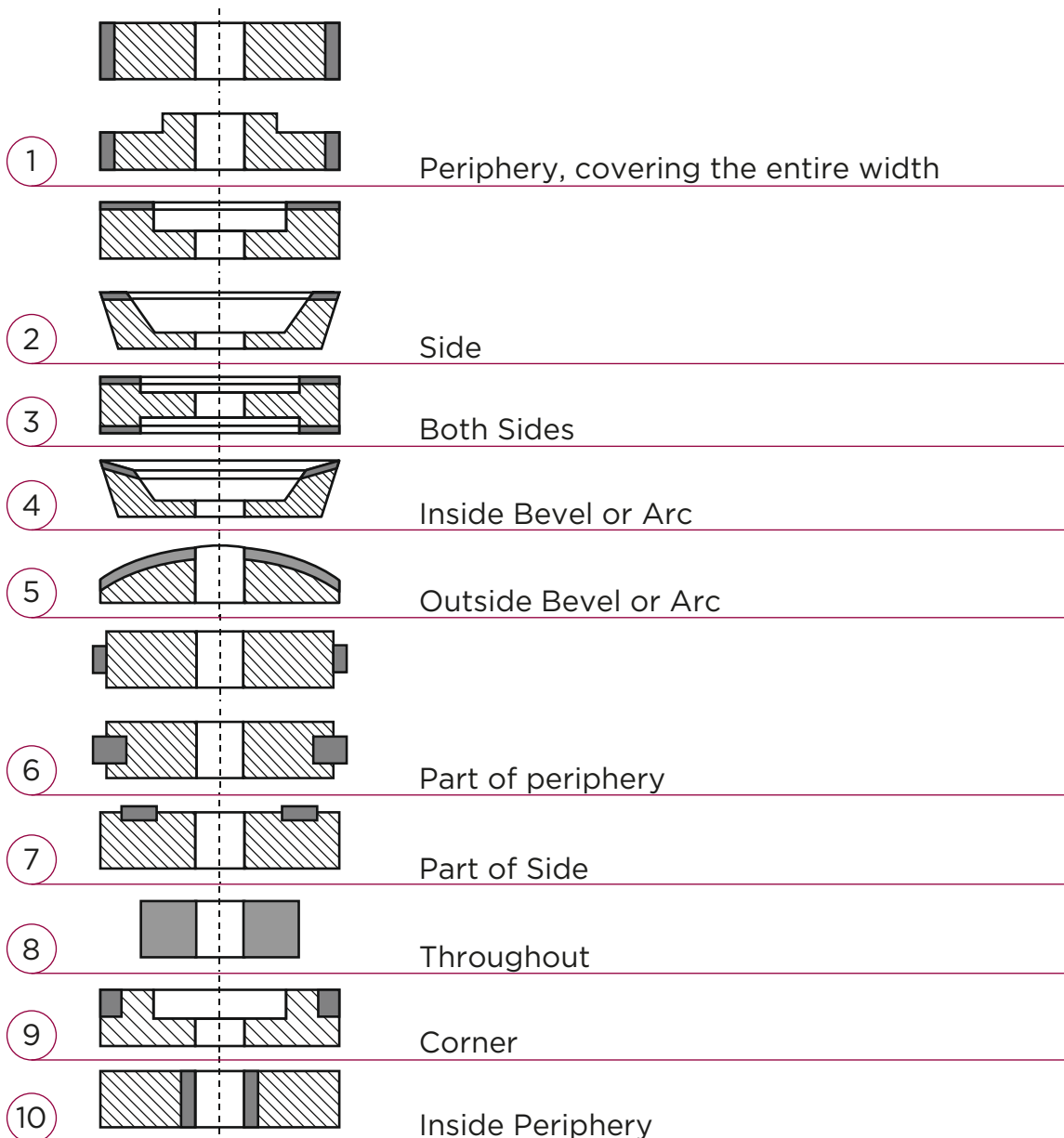

RECOMMENDATIONS FOR THE USE, TRUING AND DRESSING OF DIAMOND WHEELS

When using diamond grinding wheels, the following instructions should be observed:

- Grinding wheels are to be mounted on holders or flanges and should not be removed until final usage has occurred. The tools are to be mounted securely on the machine spindle in accordance with the technical specifications of the equipment used for diamond tool machining.
- Metal bonded and vitrified bonded grinding wheels must be used with coolant, coolant is also advisable for resin bonded diamond wheels.
- The cleaning of resin bonded diamond wheels is to be performed with a pumice stone, of metal bonded wheels with a green silicon carbide bar made with grit sizes 1 or 2 sizes larger than that of the diamond wheel.

Dressing (truing) of the diamond layer is necessary to restore its shape, eliminate defects from its working surface, and to restore the required profile. As a rule this is performed without coolant. The most productive way of dressing a diamond layer is to grind it with abrasive wheels. The dressing is performed by wheels of white alumina and green silicon carbide with vitrified bonds with grit sizes 1 or 2 sizes larger than those of the diamond wheels. Wheels with a hardness of K-H are necessary for dressing of resin bond wheels and wheels of a hardness of M-K are necessary for dressing of metal bond wheels. The smaller the grit size of the superabrasive material, the softer the dressing tool must be.

Conditions of diamond layer dressing

Diamond grinding wheel position	Dressing conditions			
	Peripheral speed, m/s		Line feed m/min	Cross feed, mm/double stroke
	Abrasive wheel	Diamond wheel		
Diamond grinding wheel set on a machine fixture or in the center of a circular grinding or sharpening machine	25-35	1,0-2,0	1,0-2,0	0,02-0,04

Characteristics of vitrified bonded abrasive wheels for dressing of diamond layer

Diamond layer characteristics		Characteristics of dressing wheel		
Type of bonds	Diamond grade, FEPA Standard	Abrasive type	Abrasive grades, FEPA Standard	Hardness
Resin bonds	D181-D126	Aluminum oxide	70-100	M-L
	D107-D76		100-150	L-K
	D64-D46		150-220	K-J
	M40-M16		360-400	J
Vitrified bonds, Metal bonds	D251-D213	Silicon carbide	46-54	O-N
	D181-D126		60-70	N-M
	D107-D76		80-100	M-L
	D64 and lower		120-180	L-K

Comparison of diamond tools quality lines

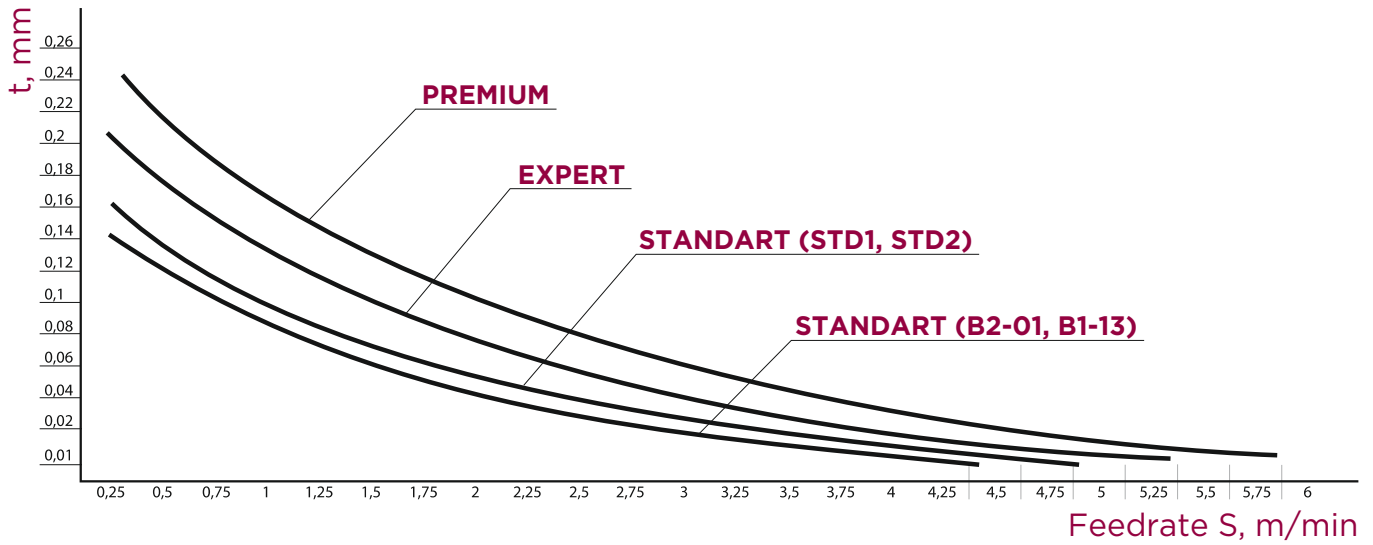

Wear-resistance - grinding performance chart (diamond)

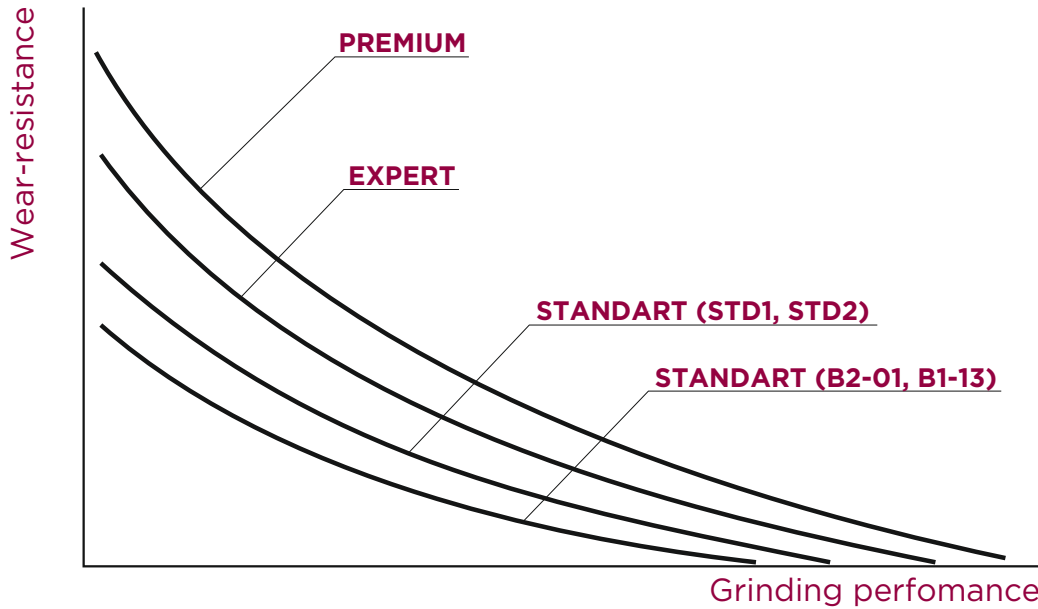

Profile retention of diamond tools quality lines

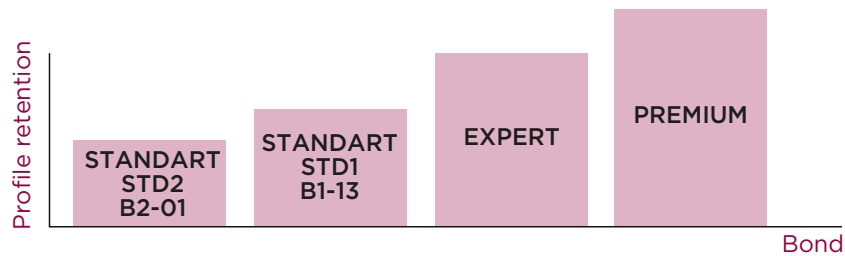

Bond softness chart (diamond)



Grinding ability of the bonds (CBN)

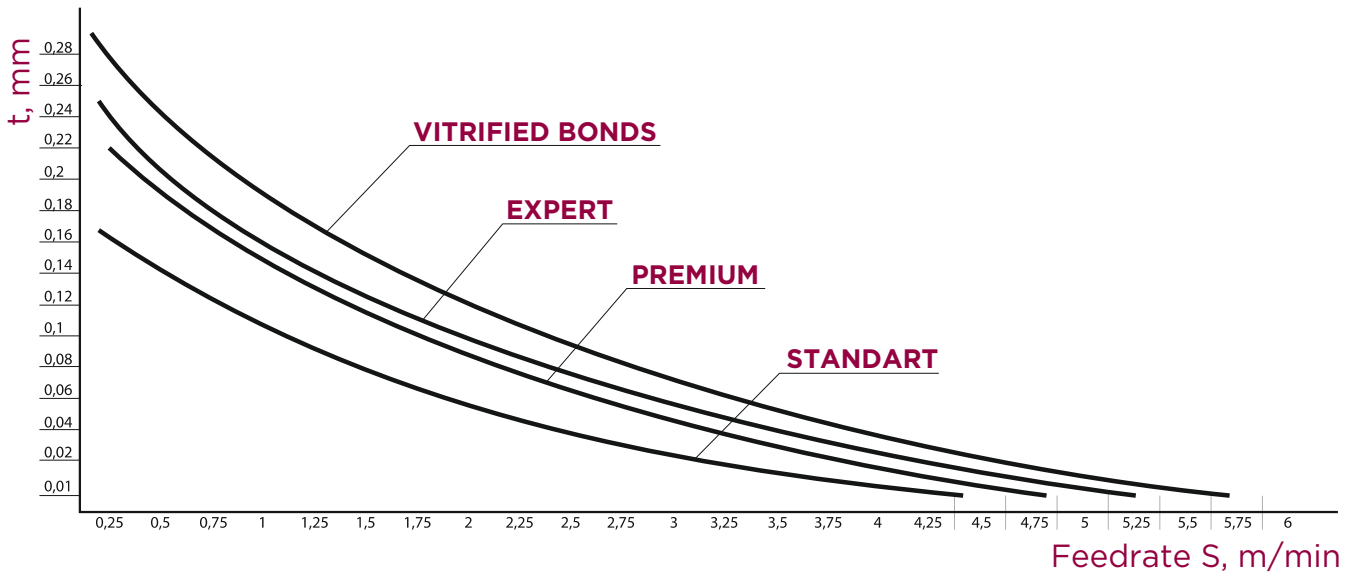

Wear-resistance - grinding performance chart (CBN)

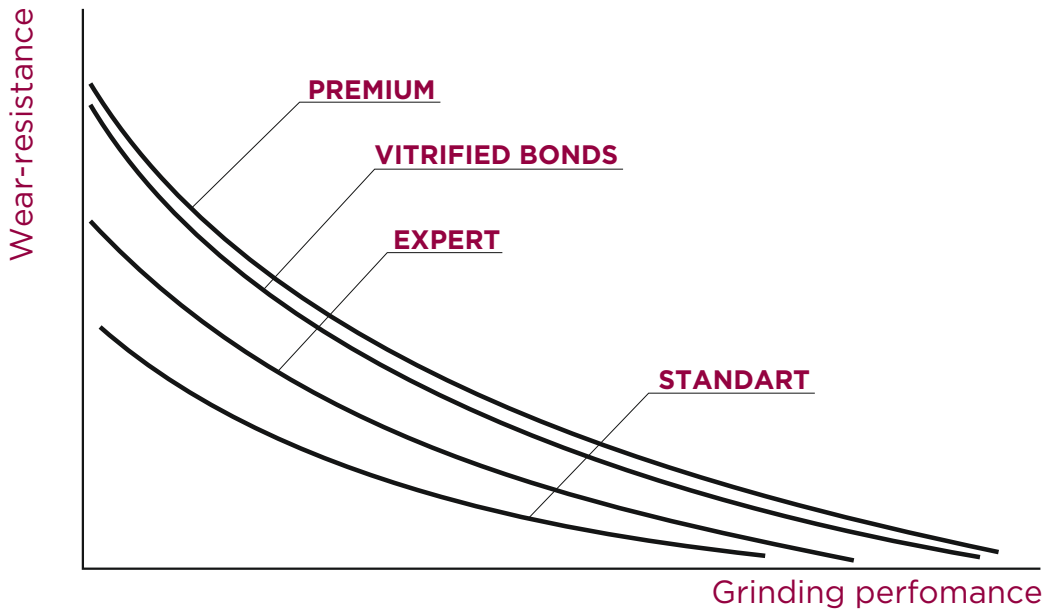

Profile retention of bonds (CBN)

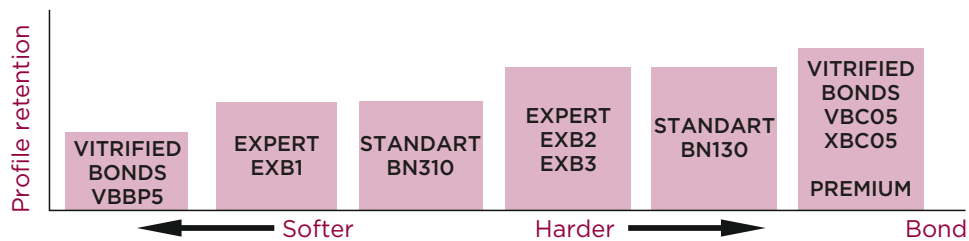

Grinding temperature (CBN)

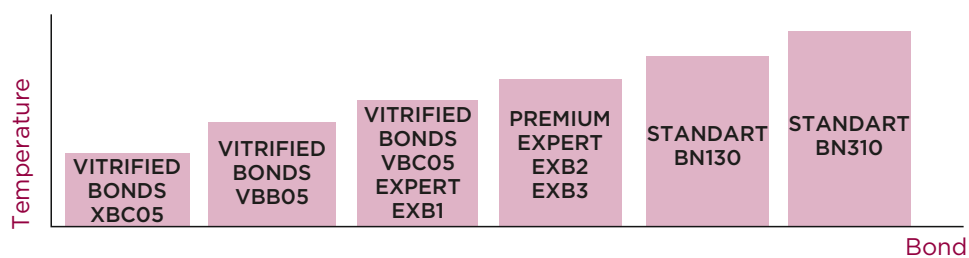

**CALCULATION OF SPINDLE TURNS FOR GRINDING WHEELS
OF DIFFERENT DIAMETERS AT A GIVEN PERIFERAL SPEED, rpm.**

Wheel diameter, mm	Peripheral speed, m/s									
	10	15	20	25	30	35	40	45	50	60
3	63 700	95 540								
4	47 770	71 660	95 540							
5	38 220	57 320	76 440	95 540						
6	31 850	47 770	63 700	79 620	95 540					
8	23 890	35 830	47 770	59 720	71 660	83 600	95 540			
10	19 110	28 660	38 220	47 770	57 320	66 880	76 440	83 980	95 540	
12	15 920	23 880	31 850	39 810	47 770	55 750	63 700	71 650	79 600	95 540
16	11 940	17 910	23 880	29 860	35 830	41 800	47 770	53 250	59 700	71 650
20	9 550	14 330	19 110	23 880	28 660	33 440	38 220	42 990	47 770	57 320
25	7 640	11 450	15 290	19 110	22 930	26 750	30 570	34 390	38 210	45 860
30	6 370	9 550	12 740	15 920	19 110	22 290	25 480	28 660	31 850	38 210
35	5 640	8 190	10 950	13 650	16 380	19 110	21 840	24 560	27 290	32 750
40	4 780	7 170	9550	11 940	14 330	16 720	19 110	21 500	23 880	28 660
45	4 250	6 370	8 490	10 610	12 740	14 860	16 980	19 110	21 230	25 480
50	3 820	5 730	7 640	9 550	11 460	13 370	15 290	17 200	19 110	22 930
60	3 180	4 780	6 370	7 960	9 550	11 150	12 740	14 330	15 920	19 110
70	2 730	4 090	5 466	6 820	8 190	9 550	10 920	12 280	13 650	16 380
75	2 550	3 820	5 090	6 370	7 640	8 910	10 190	11 460	12 740	15 280
80	2 340	3 580	4 780	5 970	7 170	8 360	9 550	10 750	11 940	14 330
90	2 120	3 180	4 250	5 310	6 370	7 430	8 490	9 550	10 610	12 740
100	1 910	2 870	3 820	4 780	5 730	6 690	7 640	8 600	9 550	11 460
110	1740	2 600	3 470	4 340	5 210	6 080	6 950	7 820	8 680	10 420
125	1 530	2 290	3 060	3 820	4 580	5 350	6 110	6 880	7 640	9 170
150	1 270	1 910	2 550	3 180	3 820	4 460	5 090	5 730	6 370	7 640
175	1 090	1 640	2 180	2 730	3 270	3 818	4 360	4 910	5 450	6 540
200	960	1 430	1 910	2 390	2 870	3 340	3 820	4 300	4 720	5 730
220	870	1 300	1 740	2 170	2 600	3 040	3 470	3 910	4 340	5 210
225	850	1 270	1 700	2 120	2 550	2 970	3 400	3 820	4 250	5 090
250	760	1 150	1 530	1 910	2 300	2 670	3 060	3 440	3 820	4 580
270	710	1 060	1 410	1770	2 120	2 470	2 830	3 180	3 530	4 240
275	690	1 040	1 390	1 730	2 080	2 430	2 770	3 120	3 460	4 160
300	640	950	1 270	1 590	1 910	2 230	2 550	2 870	3 180	3 820
340	560	840	1 120	1 400	1 690	1 970	2 250	2 530	2 810	3 370
350	540	820	1 090	1 360	1 640	1910	2 190	2 450	2 730	3 270
400	480	720	960	1 190	1 430	1 670	1 910	2 150	2 380	2 810
450	420	640	850	1 060	1 270	1 480	1 700	1 910	2 120	2 550
475	400	600	800	1 000	1 210	1 410	1 610	1 810	2 010	2 410
500	380	570	760	950	1 150	1 340	1 530	1720	1 910	2 290
585	330	490	660	820	980	1 150	1 310	1 480	1 640	1970
600	320	480	640	800	950	1 110	1 280	1 430	1 600	1 910

pdtools
SUPERABRASIVES



**METAL AND RESIN BONDED DIAMOND
AND CBN GRINDING WHEELS FOR MACHINE
BUILDING, ELECTRONICS, TOOL AND
WOODWORKING INDUSTRIES**

1A1 STRAIGHT GRINDING WHEELS

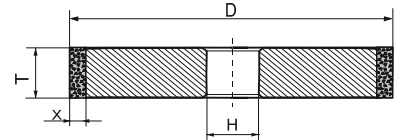

1A1 D*T*X*H

- Used for machining of conical, cylindrical and flat surfaces, cylindrical and conical apertures.
- Machining of cylindrical surface parts and surface ends at one set-up.
- Machining of recesses and slots of carbide stamps.
- Sharpening and finishing of carbide tools.
- The diamond layer is made of diamond grinding powder with metal or resin bonds.
- For metal bonded tools, coolant is required.

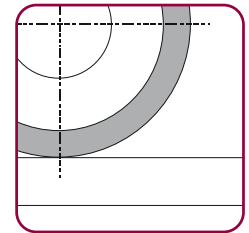

Flat surface grinding

Catalog number	D, mm	T, mm	X, mm	H, mm
0-0004	16	8	2	6
0-0005	16	13	2	6
0-0010	20	10	2	6
0-0011	20	16	2	6
0-0016	25	10	3	6
0-0018	25	16	3	6
0-0022	32	10	3	10
0-0024	32	16	3	10
0-0031	40	16	3	16
0-0037	50	16	3	16
0-0044	63	16	3	20
0-0045	80	3	3	20
0-0048	80	6	3	20
0-0054	80	6	5	20
0-0050	80	10	3	20
0-0056	80	10	5	20
0-0053	80	20	3	20
0-0059	80	20	5	20
0-0060	100	3	3	20
0-0063	100	6	3	20
0-0065	100	10	3	20
0-0071	100	10	5	20
0-0068	100	20	3	20
0-0076	125	3	3	32
0-0078	125	5	3	32
0-0079	125	6	3	32
0-0080	125	10	3	32
0-0085	125	10	5	32
0-0083	125	20	3	32
0-0088	125	20	5	32
0-0089	125	32	5	32
0-0091	150	3	3	32
0-0093	150	5	3	32
0-0094	150	6	3	32
0-0100	150	6	5	32
0-0096	150	10	3	32
0-0102	150	10	5	32
0-0099	150	20	3	32
0-0105	150	20	5	32
0-0109	200	6	3	76
0-0111	200	10	3	76

Customer-specific and other grinding tools can be produced on request.

Catalog number	D, mm	T, mm	X, mm	H, mm
0-0116	200	10	5	76
0-0114	200	20	3	76
0-0119	200	20	5	76
0-0120	200	40	5	76
0-0126	250	10	5	76
0-0128	250	15	5	76
0-0129	250	20	5	76
0-0130	250	40	5	76
0-0131	250	50	5	76
0-0137	300	15	5	76
0-0145	300	15	5	127
0-0138	300	20	5	76
0-0146	300	20	5	127
0-0139	300	40	5	76
0-0149	350	20	5	127
0-0158	400	25	4	203
0-0154	400	25	6	127
0-0155	400	40	6	127
0-0159	400	40	6	203
0-0162	500	20	6	203
0-0164	500	40	6	203
0-0169	500	50	6	305
600-25	600	25	6	127
600-40	600	40	6	305

Customer-specific and other grinding tools can be produced on request.

Straight grinding wheel 1A1 (special)

Catalog number	D, mm	T, mm	X, mm	H, mm
9-6643	40	10	3	20
9-9603	63	3	2,5	20
9-9604	63	3	3	20
9-6944	100	16	2	17
9-8130	142	16	2	24
9-8144	152	19	3	25,4
9-8139	155	15	3	20
9-6950	200	20	3	32
9-3230	200	88	5	127

Customer-specific and other grinding tools can be produced on request.

1A1

STRAIGHT GRINDING WHEELS

compound

- Used for machining cylindrical surfaces, centerless grinding.
- The diamond layer is made of diamond grinding powder with metal or resin bonds.
- For metal bonded tools coolant is required.

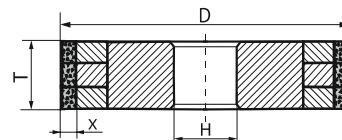

1A1 D*T*X*H

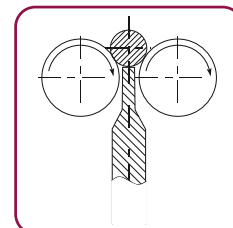

Centerless grinding

Catalog number	D, mm	T, mm	X, mm	H, mm
9-6993	300	100	5	127
0-2821	350	100	5	200
9-6997	350	100	5	127
9-6998	350	100	5	203
9-9606	400	150	5	203
9-6999	400	150	5	305
9-2034	500	200	3	304,8
9-2033	500	200	6	304,8

Customer-specific and other grinding tools can be produced on request.

14U1

THREE-SIDED GRINDING WHEELS

- Used for grinding carbide workpieces (flute grinding).
- The diamond layer is made of diamond grinding powder with metal or resin bonds.
- For metal bonded tools coolant is required.

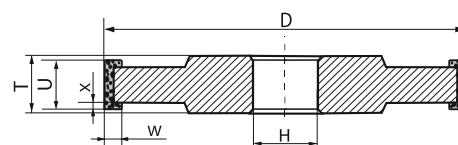

14U1 D*T*U*W*X*H

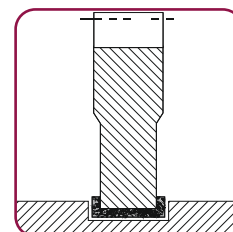

Flute grinding

Catalog number	D, mm	T, mm	U, mm	W, mm	X, mm	H, mm
0-0201	125	10	6	4	2	32
0-0202	125	10	8	4	2	32
0-0203	150	12	8	4	2	32
0-0204	150	12	10	4	2	32
0-0205	150	12	8	6	2	32
0-0206	150	12	10	6	2	32
0-0208	150	12	10	4	2	51
0-0210	150	12	10	6	2	51
0-0211	200	16	12	6	3	32
0-0212	200	16	14	6	3	32
0-0213	200	16	12	10	3	32
0-0214	200	16	14	10	3	32
0-0218	200	16	14	10	3	51
0-0219	250	20	16	8	3	76
0-0220	250	20	20	8	3	76
0-0221	250	20	16	12	3	76
0-0222	250	20	20	12	3	76

Customer-specific and other grinding tools can be produced on request.

STRAIGHT FLAT GRINDING WHEELS

14A1

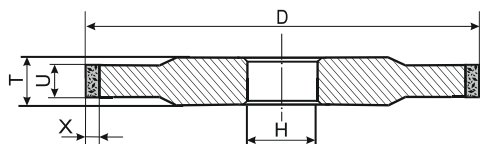

14A1 D*T*U*X*H

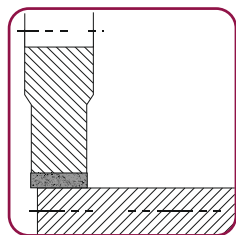

Cylindrical surface grinding



- Used for machining of conical, cylindrical and flat surfaces, cylindrical and conical apertures, sharpening and finishing of carbide tools.
- The diamond layer is made of diamond grinding powder with metal or resin bonds.
- For metal bonded tools coolant is required.

Catalog number	D, mm	T, mm	U, mm	X, mm	H, mm
0-0301	100	6	3	3	20
0-0302	100	6	5	3	20
0-0303	100	6	3	5	20
0-0304	100	6	5	5	20
0-0305	125	6	3	3	32
0-0306	125	6	5	3	32
0-0307	125	6	3	5	32
0-0308	125	6	5	5	32
0-0309	150	8	3	3	32
0-0310	150	8	5	3	32
0-0311	150	8	3	5	32
0-0312	150	8	5	5	32
0-0315	150	10	7	7	32
0-0316	150	10	9	7	32
0-0317	175	8	3	3	51
0-0318	175	8	5	3	51
0-0319	175	8	3	5	51
0-0320	175	8	5	5	51
0-0321	200	10	3	3	51
0-0322	200	10	5	3	51
0-0323	200	10	3	5	51
0-0324	200	10	5	5	51
0-0327	200	10	7	7	51
0-0328	200	10	9	7	51
0-0329	250	10	3	5	51
0-0330	250	10	5	5	51
0-0333	250	10	7	7	51
0-0334	250	10	3	5	76
0-0335	250	10	5	6	76
0-0338	250	10	7	7	76

Customer-specific and other grinding tools can be produced on request.

3A1 STRAIGHT GRINDING WHEELS

- Used for processing of cylindrical and flat surfaces on cylindrical and surface grinding machines.
- The diamond layer is made of diamond grinding powder with metal or resin bonds.
- For metal bonded tools coolant is required.

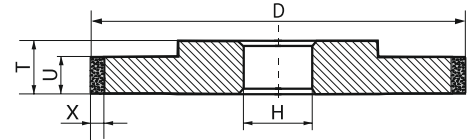

3A1 D*T*U*X*H

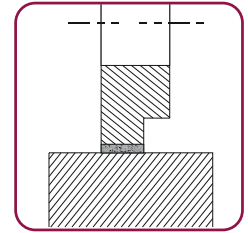

Flat surface grinding

Catalog number	D, mm	T, mm	U, mm	X, mm	H, mm
9-5030	150	10	2	3	31,75
9-5031	150	10	3	3	31,75
9-5032	200	10	3	3	31,75
9-5021	300	14	5,5	3	127
9-5022	300	19	8	3	127
9-5023	300	14	10	3	127
9-5024	300	14	12	3	127
9-5020	350	22	10	5	127

Customer-specific and other grinding tools can be produced on request.

9A3 FLAT GRINDING WHEELS WITH DOUBLE-SIDED RECESS

- Used for sharpening and finishing of carbide tools, machining of glass, ceramics, quartz, semiconducting materials.
- The diamond layer is made of diamond grinding powder with metal or resin bonds.
- For metal bonded tools coolant is required.

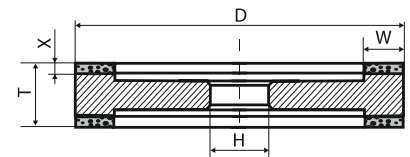

9A3 D*W*X*T*H

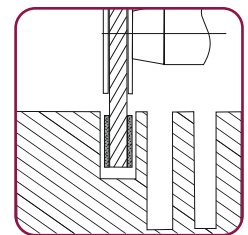

One-pass groove grinding

Catalog number	D, mm	W, mm	X, mm	T, mm	H, mm
3-0132	100	6	1,5	10	20
3-0135	125	10	2	20	32
3-0136	125	15	2	20	32
3-0137	150	6	3	16	32
3-0138	150	10	3	16	32
3-0139	150	20	3	16	32
3-0149	200	20	3	16	32
3-0160	250	10	3	21	76
3-0161	250	20	3	21	76

Customer-specific and other grinding tools can be produced on request.

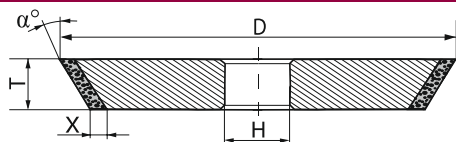

1V1 D*T*X* α *H

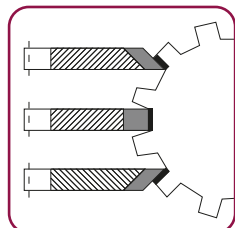

Machining of teeth



- Used for grinding of cylindrical and tapered surfaces.
- The diamond layer is made of diamond grinding powder with metal or resin bonds.
- For metal bonded tools coolant is required.

Catalog number	D, mm	T, mm	X, mm	α°	H, mm
0-7346	75	8	5	30	20,00
9-3206	100	12	6	15	31,75
9-3207	100	12	6	30	31,75
9-3208	100	12	6	45	31,75
9-3209	125	12	6	15	31,75
9-3211	125	12	6	20	31,75
9-3212	125	12	6	25	31,75
9-3213	125	12	6	30	31,75
9-3214	125	12	3	10	31,75
9-3215	125	12	3	15	31,75
9-3216	125	12	3	20	31,75
9-3217	125	12	3	25	31,75
9-3218	125	12	3	30	31,75
9-3219	125	12	3	45	31,75
9-3220	125	6	6	30	50,80
9-3222	100	10	3	20	20,00
9-3223	125	12	3	20	20,00
9-3241	125	10	6	45	31,75
9-3248	100	6	5	30	31,75
9-3249	100	6	5	45	31,75

Customer-specific and other grinding tools can be produced on request.

pdtools
SUPERABRASIVES

1A1R CUT-OFF WHEELS

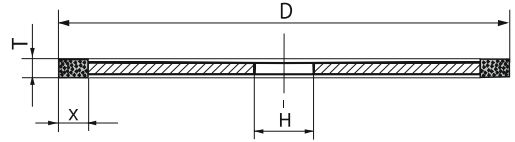

1A1R D*T*X*H

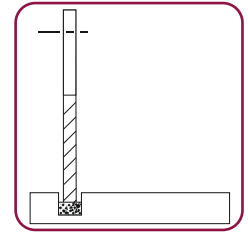

Material cutting

- Used for cutting carbide, glass, marble, quartz, semiconducting materials, ceramics, decorative stones.
- The diamond layer is made of diamond grinding powder with metal or resin bonds.
- For metal bonded tools coolant is required.

Catalog number	D, mm	T, mm	X, mm	H, mm
6-0127	50	1,0	5	12
6-0167	100	1,0	5	20
6-0187	125	1,0	5	32
6-0189	125	1,2	5	32
6-0212	150	1,0	5	32
6-0219	150	1,2	5	20
6-0214	150	1,2	5	32
6-0216	150	1,5	5	32
6-0223	175	1,0	5	32
6-0225	175	1,5	5	32
6-0229	200	1,0	5	32
6-0682	200	1,2	10	32
6-0232	200	1,2	5	32
6-0234	200	1,5	5	32
6-0236	200	2,0	5	32
6-0238	200	2,2	5	32
6-0241	250	1,5	5	32
6-0243	250	2,0	5	32
6-0245	250	2,2	5	32
6-0691	300	2,2	5	32
6-0703	350	2,2	5	32
6-0707	350	2,2	5	76
6-0705	350	2,2	10	32
6-0712	400	2,2	5	32
6-0267	400	2,2	5	76

Customer-specific and other grinding tools can be produced on request.

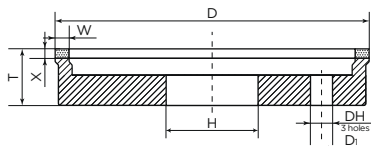

RECESSED FLAT GRINDING WHEELS 6A2

6A2 D*W*X*T*H

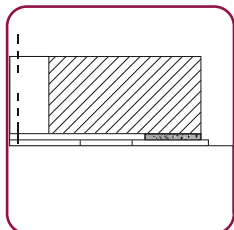

Surface grinding



- Used for sharpening and finishing of carbide tools (cutters, drills and others).
- Machining of glass, ceramics, quartz, semiconductors and other non-metal materials.
- The diamond layer is made of diamond grinding powder with metal or resin bonds.
- For metal bonded tools coolant is required.

Catalog number	D, mm	W, mm	X, mm	T, mm	H, mm
3-0001	50	3	2	22	16
3-0002	50	5	2	22	16
3-0004	75	5	2	22	20
3-0005	75	10	2	22	20
3-0007	100	5	2	22	20
3-0008	100	10	2	22	20
3-0009	100	15	2	22	20
3-0011	100	5	4	24	20
3-0012	100	10	4	24	20
3-0013	100	15	4	24	20
3-0019	125	6	2	22	32
3-0020	125	10	2	22	32
3-0021	125	15	2	22	32
3-0023	125	6	4	24	32
3-0024	125	10	4	24	32
3-0025	125	15	4	24	32
3-0026	150	6	4	24	32
3-0027	150	10	4	24	32
3-0028	150	20	4	24	32
3-0035	150	6	6	26	51
3-0036	150	10	6	26	51
3-0037	150	20	6	26	51
3-0038	200	10	4	29	51
3-0039	200	20	4	29	51
3-0057	250	20	4	29	76
3-0058	250	40	4	29	76

Flat grinding wheels 6A2 special

Catalog number	D, mm	W, mm	X, mm	T, mm	H, mm
3-2111	50	4	2	10	16
3-0170	100	35	5	20	20
3-0171	150	30	5	20	20
3-1306	250	60	3	23	51
3-1401	500	50	8	34	325

Flat grinding wheels 6A2 special, electroplated

Catalog number	D, mm	W, mm	T, mm	H, mm
6-1217	360	165	18	160
6-1218	400	185	18	160
6-1221	500	235	18	160
6-1219	600	285	18	160
6-1220	700	305	18	200

Customer-specific and other grinding tools can be produced on request.

6A2T FLAT GRINDING WHEELS

- Used for machining of flat and shaped surfaces of glass, ceramics, quartz, semiconductors, and decorative stones.
- The diamond layer is made of diamond grinding powder with metal bonds.
- Coolant is required.

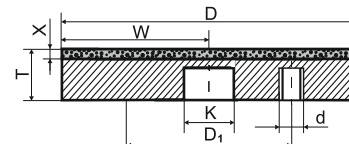
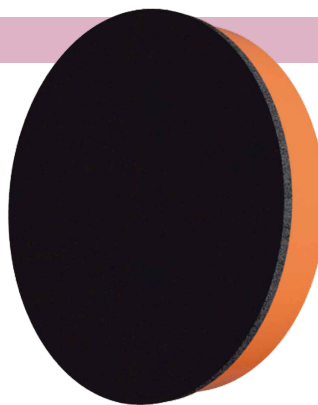

6A2T D*W*X*T*D1*d*H

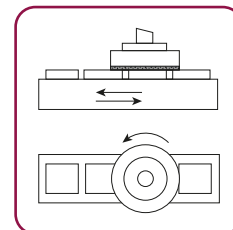

Surface grinding

Catalog number	D, mm	W, mm	X, mm	T, mm	D1, mm	d, mm	H, mm
3-0201	100	50	3	18	70	M8	40
3-0202	150	75	3	18	70	M8	40
3-0203	200	100	3	18	150	M8	80
3-0204	250	125	3	18	150	M8	80
3-0205	300	150	3	20	260	M10	80
3-2807	400	200	2,4	20	260	M10	80

Customer-specific and other grinding tools can be produced on request.

12A2-20 DISH GRINDING WHEELS

- Used for sharpening and finishing of front surfaces of ream teeth, cutters, circular saws, drawing dies and tools made of tungsten carbide.
- The diamond layer is made of diamond grinding powder with metal or resin bonds.
- For metal bonded tools coolant is required.

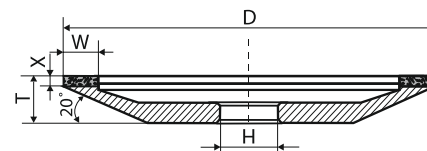

12A2-20 D*T*X*W*H

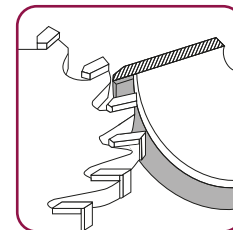

Tool face sharpening

Catalog number	D, mm	T, mm	X, mm	W, mm	H, mm
5-0005	75	10	2	3	16
5-0006	75	10	2	6	16
5-0007	100	12	2	3	20
5-0008	100	12	2	6	20
5-0009	125	16	2	3	32
5-0010	125	16	2	6	32
5-0011	125	16	2	10	32
5-0012	150	18	2	3	32
5-0013	150	18	2	6	32
5-0014	150	18	2	10	32
5-0018	200	22	2	10	51
9-5045	50	10	2,2	2,3	16
5-1011	75	10	2	6	20
9-3151	125	12	1,5	6 (3+3)	32
9-5006	150	19	3	10	32
9-5042	175	21	3	10	32

Customer-specific and other grinding tools can be produced on request.

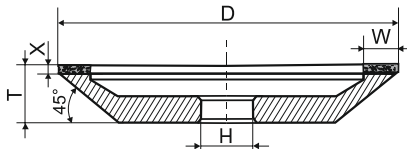

CUP GRINDING WHEELS 12A2-45

12A2-45 D*W*X*T*H

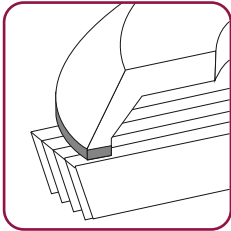

Face grinding

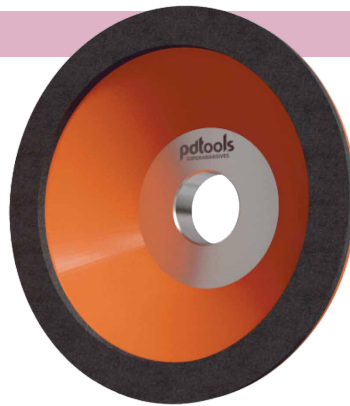

- Used for sharpening and finishing of front and back surface of multiple-blade carbide tools (with straight and spiral teeth), cutters, drills and other tools.
- Used for processing of flat machine part surfaces, semiconductors, ceramic materials, precious stones, quartz and other materials.
- The diamond layer is made of diamond grinding powder with metal or resin bonds.
- For metal bonded tools coolant is required.

Catalog number	D, mm	W, mm	X, mm	T, mm	H, mm
4-0004	50	3	3	21	16
4-0117	75	3	3	21	20
4-0118	75	6	3	21	20
4-0015	100	3	3	32	20
4-0016	100	5	3	32	20
4-0017	100	10	3	32	20
4-0027	125	3	3	40	32
4-0028	125	5	3	40	32
4-0029	125	10	3	40	32
4-0031	125	5	5	42	32
4-0040	150	10	3	40	32
4-0043	150	10	5	42	32
4-0041	150	20	3	40	32
4-0044	150	20	5	42	32
4-0073	200	10	3	50	51
4-0074	200	20	3	50	51
4-0076	200	20	5	52	51
4-0092	250	20	3	50	76

Customer-specific and other grinding tools can be produced on request.

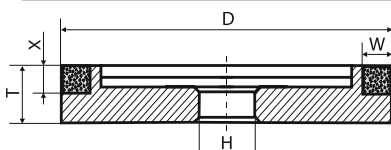

6A9 D*W*X*T*H

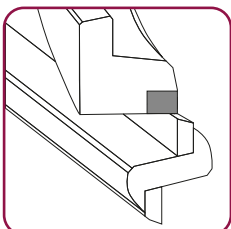

Saw end surface sharpening



RECESSED FLAT GRINDING WHEELS 6A9

- Used for sharpening and finishing of special tools.
- The diamond layer is made of diamond grinding powder with resin bonds.
- For metal bonded tools coolant is required.

Catalog number	D, mm	W, mm	X, mm	T, mm	H, mm
9-8150	100	3	6	30	20

Customer-specific and other grinding tools can be produced on request.

12V9-20 DISH GRINDING WHEELS

(PREMIUM LINE)

- Used for sharpening and finishing (face grinding) of circular saw teeth and other tungsten carbide tools.

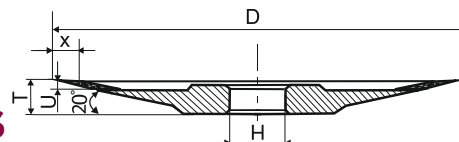

12V9-20 D*T*X*U*H

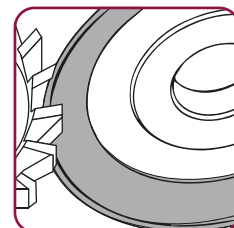

Face grinding

Catalog number	D, mm	T, mm	X, mm	U, mm	H, mm
3-3042	100	10	2,3	4	25
4-4026	120	13	2,5	4	32
3-3048	125	13	2,5	4	32
3D3048	125	13	2,5	4	20
3-3045	150	13	2,3	4	32
4-4026	160	13	2,3	4	32
3-3043	175	13	2,5	4	32
3-3049	200	13	2,3	4	32

Customer-specific and other grinding tools can be produced on request.

4A2 DISH GRINDING WHEELS

- Used for sharpening and finishing (face and top grinding) of multiple-blade tools.
- The diamond layer is made of diamond grinding powder with metal or resin bonds.

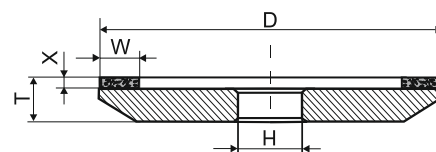

4A2 D*T*X*W*H

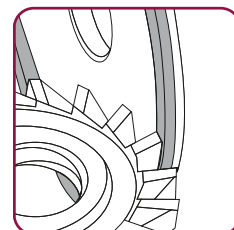

Top grinding

Catalog number	D, mm	T, mm	X, mm	W, mm	H, mm
9-8151	100	10	2	3	20
4-1140	100	10	1	6	22,20
4-1116	100	10	1,5	6	31,75
9-9161	125	10	3	6	31,75
9-9166	125	10	3	6	32
9-9165	125	10	2	8	20
9-3153	125	18	5	6	32
9-8158	150	12	3	5	20
9-9162	150	12	3	6	31,75
9-9167	150	12	3	6	32
4-1141	300	50	2	8	76

Customer-specific and other grinding tools can be produced on request.

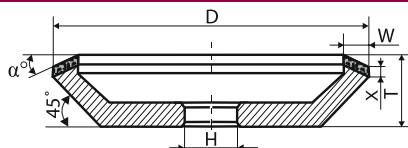

CUP GRINDING WHEELS 12V5-45

12V5-45 D*T*W*X*α*H

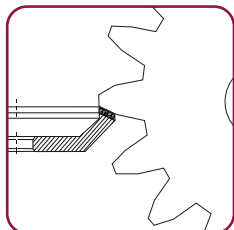

Ram sharpening



- Used for sharpening and finishing (top grinding) of multiple-blade carbide tools (with straight and spiral teeth), cutters, drills and other tools.
- Used for processing of semiconductors, ceramic material, quartz and other materials.
- The diamond layer is made of diamond grinding powder with metal or resin bonds.
- For metal bonded tools coolant is required.

Catalog number	D, mm	T, mm	W, mm	X, mm	α°	H, mm
4-0121	50	20	3	3	15	16
4-0122	50	20	3	3	25	16
4-0123	75	25	3	3	15	20
4-0124	75	25	3	3	25	20
4-0125	75	25	6	3	15	20
4-0126	75	25	6	3	25	20
4-0127	100	32	3	4	15	20
4-0128	100	32	3	4	25	20
4-0129	100	32	6	4	15	20
4-0130	100	32	6	4	25	20
4-0131	125	40	3	4	15	32
4-0132	125	40	3	4	25	32
4-0133	125	40	6	4	15	32
4-0134	125	40	6	4	25	32
4-0135	150	40	6	5	15	32
4-0136	150	40	6	5	25	32
4-0137	150	40	6	5	15	51
4-0138	150	40	6	5	25	51

Customer-specific and other grinding tools can be produced on request.

12D9 DISH GRINDING WHEELS

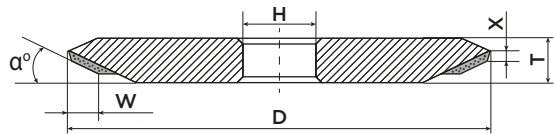

12D9 D*W*X*T*α*H

- Used for sharpening and finishing of front and back surfaces of carbide tools.
- The diamond layer is made of diamond grinding powder with metal or resin bonds.
- For metal bonded tools coolant is required.

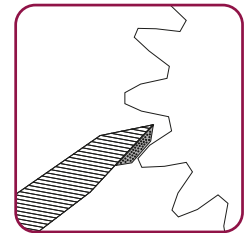

Face grinding

Catalog number	D, mm	W, mm	X, mm	T, mm	α°	H, mm
5-0102	125	4	2	11	20	32
5-0104	125	8	2	11	20	32
5-0106	150	8	3	13	20	32
5-0108	150	16	3	13	20	32
5-0113	200	25	3	16	15	32
5-0114	200	25	3	16	20	32
5-0126	250	16	3	20	20	76
5-0125	250	16	3	20	15	76

Customer-specific and other grinding tools can be produced on request.

12V9-45 DISH GRINDING WHEELS

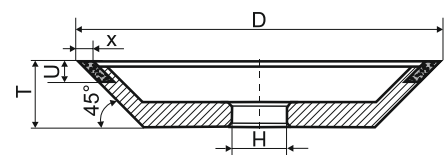

12V9-45 D*U*X*T*H

- Used for sharpening and finishing of cutting tool back surfaces.
- The diamond layer is made of diamond grinding powder with metal or resin bonds.
- For metal bonded tools coolant is required.

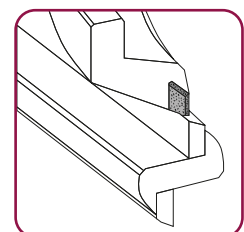

Top grinding

Catalog number	D, mm	U, mm	X, mm	T, mm	H, mm
4-2513	75	10	4	12	31,75
4-2503	75	6	1,5	18	31,75
4-1503	75	6	2	20	20
9-3154	75	6	3,5	20	10
4-2510	100	6	1,5	18	31,75
4-1510	100	10	2	20	20
4-2512	100	10	3	20	31,75
9-3108	125	10	3	25	20

Customer-specific and other grinding tools can be produced on request.

DISH GRINDING WHEELS 12R4

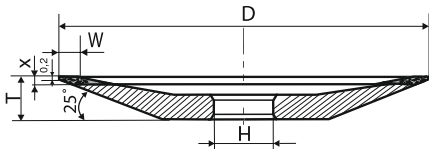

12V5-45 D*T*W*X*α*H

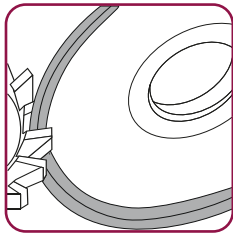

Face grinding



- Used for sharpening and finishing of front surfaces of reamer teeth, cutters, circular saws, drawing dies and tools made of tungsten carbide.
- The diamond layer is made of diamond grinding powder with metal or resin bonds.
- For metal bonded tools coolant is required.

Catalog number	D, mm	W, mm	X, mm	T, mm	H, mm
5-0041	50	2	1,5	6	16
5-0042	75	3	2	10	20
5-0043	100	3	2	10	32
5-0045	150	5	3	16	32
5-1031	100	3	2	10	32
5-1041	125	3	2	13	32
5-1051	150	5	3	16	32
5-1052	150	5	3	16	51
3-3047	200	4	2	13	32

Customer-specific and other grinding tools can be produced on request.

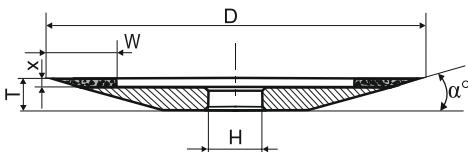

4B2 D*T*X*W*α*H

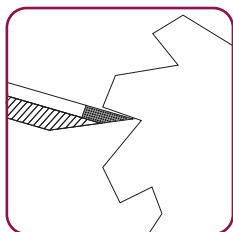

Face grinding



DISH GRINDING WHEELS 4B2

- Used for sharpening and finishing of tool front surfaces.
- The diamond layer is made of diamond grinding powder with resin bonds.
- For metal bonded tools coolant is required.

Catalog number	D, mm	T, mm	X, mm	W, mm	α°	H, mm
8-7002	100	10	1,5	6	20	31,75
8-7004	150	12	1,5	6	20	31,75
8-7008	125	10	2	6	20	32
8-7009	150	12	1,5	6	20	32
8-7010	100	10	1,5	6	20	32

Customer-specific and other grinding tools can be produced on request.

3V1

GRINDING WHEELS

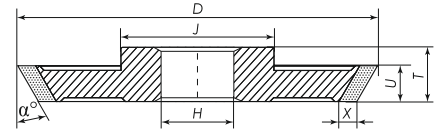

3V1 D*T*U*X*α*H

- Grinding wheels are used for chip-breaker grinding, slotting and cutting surface profiling of shaft tools etc.
- The diamond layer is made of diamond grinding powder with metal or resin bonds.
- For metal bonded tools coolant is required.

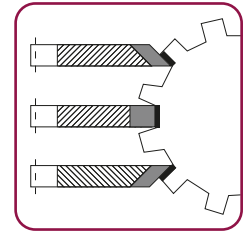

Machining of teeth

Catalog number	D, mm	T, mm	U, mm	X, mm	α°	H, mm
9-5064	125	8	6	5	15	31,75
9-5065	100	8	5	10	45	31,75
9-5066	125	6	3	5	10	31,75
9U5063	100	6	3	10	15	31,75

Customer-specific and other grinding tools can be produced on request.

1B1

GRINDING WHEELS

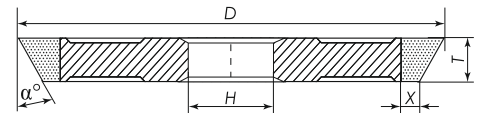

1B1 D*T*X*α*H

- Grinding wheels are used for chip-breaker grinding, slotting and cutting surface profiling of shaft tools etc.
- The diamond layer is made of diamond grinding powder with metal or resin bonds.
- For metal bonded tools coolant is required.

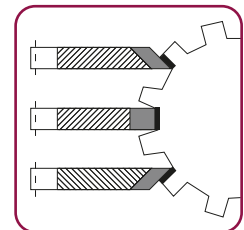

Machining of teeth

Catalog number	D, mm	T, mm	X, mm	α°	H, mm
OE 0327	200	7	7	30	76
FM1B53	75	10	10	20	20

Customer-specific and other grinding tools can be produced on request.

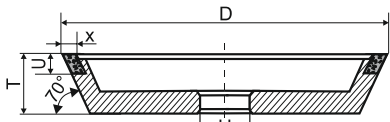

TAPERED CUP GRINDING WHEELS

11V9-70

11V9-70 D*U*X*T*H

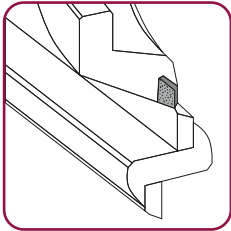

Sharpening of back and side surfaces



- Used for sharpening and finishing of back and side surfaces of carbide tools.
- The diamond layer is made of diamond grinding powder with metal or resin bonds.
- For metal bonded tools coolant is required.

Catalog number	D, mm	U, mm	X, mm	T, mm	H, mm
4-0101	50	3	1,5	20	16
4-0102	75	6	2	32	20
4-0103	100	6	2	40	20
4-0104	100	10	2	40	20
4-0105	125	6	3	40	32
4-0106	125	8	3	40	32
4-0107	125	10	3	40	32
4-0108	150	6	3	40	32
4-0109	150	10	3	40	51

Customer-specific and other grinding tools can be produced on request.

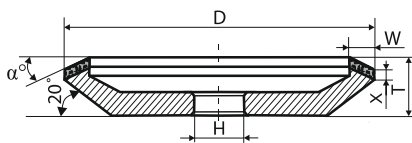

DISH GRINDING WHEELS

12V5-20

12V5-20 D*T*W*X* α *H

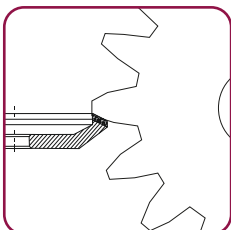

Ram sharpening



- Used for sharpening and finishing of multiple-blade tools, cutter back surfaces (with straight and spiral teeth), drills and other tools made of tungsten carbide.
- Used for processing of semiconducting materials, ceramic materials, quartz and other materials.
- The diamond layer is made of diamond grinding powder with metal or resin bonds.
- For metal bonded tools coolant is required.

Catalog number	D, mm	T, mm	W, mm	X, mm	α°	H, mm
5-0078	75	10	5	2	25	20
5-0080	100	10	3	2	25	20
5-0086	125	13	5	2	25	32
5-0090	150	16	10	3	25	32

Customer-specific and other grinding tools can be produced on request.

1FF1 FLAT GRINDING WHEELS

WITH SEMICIRCULAR-CONVEX PROFILE

- Used for machining chip-breaking flutes in tools.
- Profile grinding.
- The diamond layer is made of diamond grinding powder with metal or resin bonds.
- For metal bonded tools coolant is required.

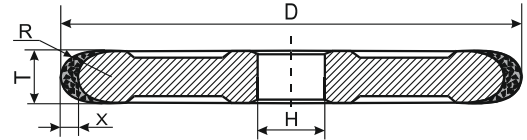

1FF1 D*T*X*R*H

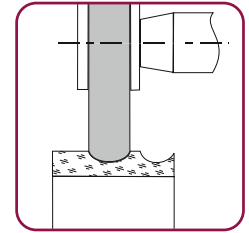

Profile grinding

Catalog number	D, mm	U, mm	X, mm	T, mm	H, mm
9-0001	50	2	2	1,0	16
9-0002	50	3	4	1,5	16
9-0003	50	4	4	2,0	16
9-0004	75	4	4	2,0	20
9-0005	75	5	4	2,5	20
9-0006	75	6	4	3,0	20
9-0007	75	8	4	4,0	20
9-0008	75	10	4	5,0	20
9-0009	100	4	4	2,0	20
9-0010	100	5	4	2,5	20
9-0011	100	6	4	3,0	20
9-0012	100	8	4	4,0	20
9-0013	100	10	4	5,0	20
9-0014	100	12	6	6,0	20
9-0015	100	16	6	8,0	20
9-0016	100	20	6	10,0	20
9-0017	125	4	4	2,0	32
9-0018	125	5	4	2,5	32
9-0019	125	6	4	3,0	32
9-0020	125	8	4	4,0	32
9-0021	125	10	4	5,0	32
9-0022	125	12	6	6,0	32
9-0023	125	16	6	8,0	32
9-0024	125	20	6	10	32
9-0025	150	10	4	5	32
9-0027	150	16	4	8	32
9-0028	150	20	6	10	32
9-0029	200	20	6	10	51
9-0030	200	30	6	15	51
9-0031	250	20	6	10	51
5-9156	80	40	5	26	32
5-9122	100	4	4	2	31,75
5-9123	100	6	4	3	31,75
5-9124	100	8	4	4	31,75
5-9125	100	10	4	5	31,75
5-9185	150	24	7	12	32
5-9188	150	32	7	16	32
9-2802	300	30	5	15	42

Customer-specific and other grinding tools can be produced on request.

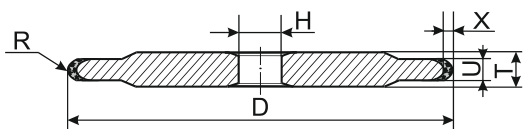

DIAMOND GRINDING WHEELS 14FF1

14FF1 D*T*U*X*R*H

WITH SEMICIRCULAR-CONVEX PROFILE

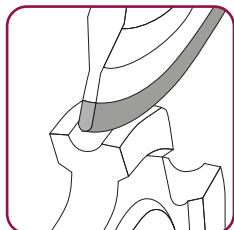

Profile grinding



- Used for machining chip-breaking flutes in tools.
- Profile grinding.
- The diamond layer is made of diamond grinding powder with metal or resin bonds.
- For metal bonded tools coolant is required.

Catalog number	D, mm	T, mm	U, mm	X, mm	R, mm	H, mm
9-2515	150	8,5	4	4	2	32
9-2639	200	10	3	4	1,5	51
9-2653	200	10	3	4	1,5	60
9-2640	200	10	4	4	2	60
9-2641	200	10	5	4	2,5	60
9-2655	200	10	6	4	3	60
9-0304	200	12	10	5	5	127

Customer-specific and other grinding tools can be produced on request.

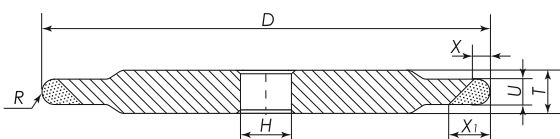

CBN GRINDING WHEELS 14F1

14F1 D*T*U*X*X1*R*H

WITH SEMICIRCULAR-CONVEX PROFILE

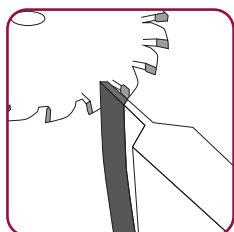

Profile grinding



- Grinding wheels for production, re-sharpening and re-profiling of HSS circular blades.

Catalog number	D, mm	T, mm	U, mm	X, mm	X1, mm	R, mm	H, mm
W-0100	150	8	1,2	4	7	0,60	32
W-0101	150	8	1,3	4	7	0,65	32
W-0102	150	8	1,5	4	7	0,75	32
W-0103	150	8	1,6	5	8	0,80	32
W-0104	150	8	1,8	5	8	0,90	32
W-0105	150	8	2,0	5	8	1,00	32
W-0106	150	8	2,5	8	12	1,25	32
W-0107	150	8	3,0	8	12	1,50	32
W-0108	150	8	3,5	8	12	1,75	32
W-0109	150	8	4,0	10	15	2,00	32
W-0110	150	8	5,0	10	15	2,50	32
W-0111	150	8	5,5	10	15	2,75	32
W-0112	150	8	6,0	10	15	3,00	32

Customer-specific and other grinding tools can be produced on request.

A8 STRAIGHT FLAT GRINDING DIAMOND WHEELS

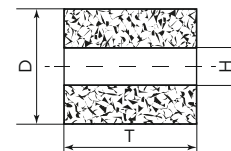

A8 D*T*H

- Circular internal grinding of cylindrical surfaces of carbide, ceramic, glass and other hard-to-machine materials.
- The diamond layer is made of diamond grinding powder and micropowders with metal or resin bonds.
- For metal bonded tools coolant is required.

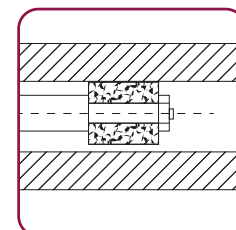

Internal grinding

Catalog number	D, mm	T, mm	H, mm
0-0181	6	6	2
0-0182	8	6	3
0-0183	8	10	3
0-0184	10	6	4
0-0185	10	10	4
0-0187	13	10	4
0-0196	25	20	6
0-0195	20	20	8
6-3024	30,5	11	8
OB0192	12	8	6
0-0192	12	10	4
0-0193	14	10	4

Customer-specific and other grinding tools can be produced on request.

AW CYLINDRICAL DIAMOND POINTS

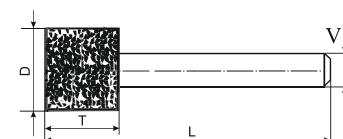

AW D*T*V*L

- Grinding of cylindrical surfaces.
- The diamond layer is made of diamond grinding powder and micropowders with metal or resin bonds.
- For metal bonded tools coolant is required.
- Hollow teeth grinding.
- Inner diameter grinding of hard metal, HSS and nonmetal workpieces.

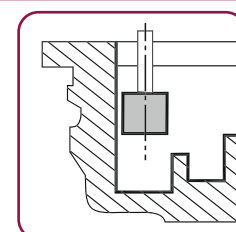

Internal grinding

Catalog number	D, mm	T, mm	V, mm	L, mm
8-1011	6	3	6	60
8-1024	8	3	8	60
8-1033	10	6	10	80
8-1042	12	6	12	80
8-1049	16	8	16	80
8-1058	20	8	20	80
8H1023	7	6	6	45
6D3051	6,5	6	6	40
6-3051	7	6	6	56,4

Customer-specific and other grinding tools can be produced on request.

DIAMOND HONING STICKS WITH THE CORPS

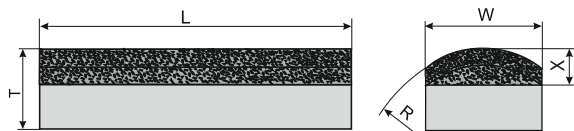

L*T*X*W*R

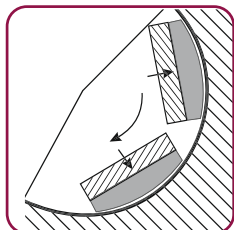

Honing

RECOMMENDATIONS FOR DIAMOND HONES

- Diamond hones are used for high-precision apertures, processing cast iron, steel and other machine parts such as cylinder blocks, cylinder liners, hubs for car and tractor engines, hydro-and pneumatic units, compressor cylinders, hubs for ship diesel engines, brake units, gears, connecting-rods, fuel pump hubs.
- The diamond layer is made of diamond grinding powder with metal or resin bonds.

Catalog number	L, mm	T, mm	X, mm	W, mm	R, mm
2-0007	50	2	1	1	2
2-0004	80	5,2	2	5	37,5
2-0005	80	5	2	3	3
8-0023	100	6	3	5	30
8-0036	100	5	3	8	40
8-0063	150	6	3	16	100
8-0054	150	6	4	12	50

Customer-specific and other grinding tools can be produced on request.

Diamond Honing Sticks (monolayer)

Code	L, mm	W, mm	T, mm
125-84	125	8	4
100-84	100	8	4
100-85	100	8	5
80-3-5	80	3	5
80-5-5	80	5	5
75-6-4	75	6	4
75-6-5	75	6	5
60-3-3	60	3	3
50-4-3	50	4	3
50-4-4	50	4	4
50-6-4	50	6	4
50-2-2	50	2	2

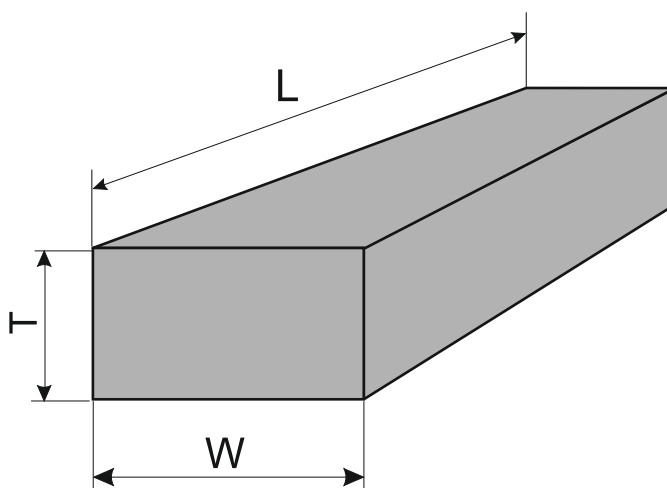

F1W SEMICIRCULAR DIAMOND MOUNTED POINTS

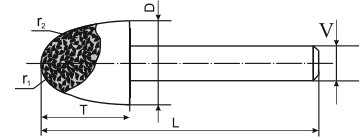

F1W D*T*L*V*r1*r2

- Internal grinding of complex surfaces.
- The diamond layer is made of diamond grinding powder and micropowders with metal or resin bonds.
- For metal bonded tools coolant is required.

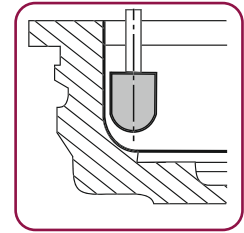

Internal profile grinding

Catalog number	D, mm	T, mm	L, mm	V, mm	r1, mm	r2, mm
9-3130	6	9	60	3	1,5	12
9-3132	8	12	60	3	1,5	15
9-3137	10	14	60	6	2	15
9-3144	12	16	80	6	2	22
9-3146	16	20	80	8	3	25
9-3148	20	24	80	8	3,5	29

Customer-specific and other grinding tools can be produced on request.

EW TAPERED DIAMOND MOUNTED POINTS

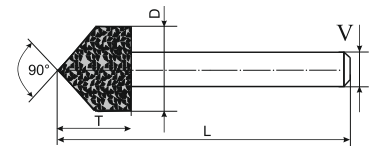

EW D*T*V*L

- Internal grinding of complex surfaces.
- The diamond layer is made of diamond grinding powder and micropowders with metal or resin bonds.
- For metal bonded tools coolant is required.

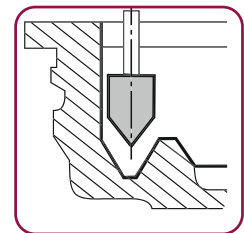

Internal grinding

Catalog number	D, mm	T, mm	V, mm	L, mm
9-3111	6	6	3	40
9-3112	6	6	4	40
9-3113	8	8	3	40
9-3114	8	8	6	40
9-3115	10	9	6	60
9-3117	12	10	6	60
9-3121	20	18	8	80

Customer-specific and other grinding tools can be produced on request.

SPECIAL DIAMOND STICKS (VERSIONS A, C)

- For dressing straight wheels and profile dressing.
- For wheels with hardness from M to Ct2.

Product advantages:

Narrow but long. The special shape of the dressing crystal permits effective profile grinding. Homogeneity of crystal structure provides stability during dressing.

Diamond disposition: type 01-chain, type 02- layered

TYPE 01, VERSION A.
CODE 800053

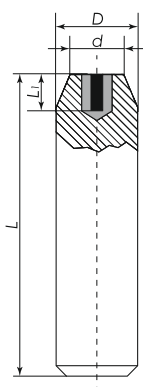

TYPE 01, VERSION A.
CODE 800054

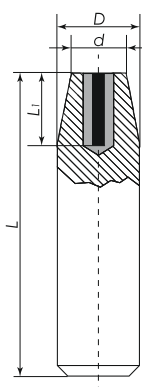

TYPE 02, VERSION C.
CODE 800083

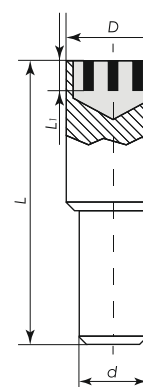

Catalog number	Type	Version	D, mm	d, mm	L, mm	L1, mm	Number of dressing crystals
800053	01	A	10	5	45	4	1
800054	01	A	10	5	45	8	1
800083	02	C	10	5	45	4	3

Customer-specific and other grinding tools can be produced on request.

Diamond dressing sticks 080094 Version C Type 04

For dressing straight abrasive wheels (hardness from M to C1) and profile dressing.

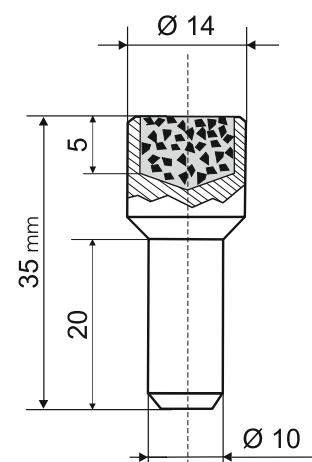

Customer-specific and other grinding tools can be produced on request.

pdtools
SUPERABRASIVES



**DIAMOND GRINDING WHEELS
FOR MACHINING OF GLASS,
CRYSTAL, DIAMONDS, CERAMICS**

MACHINING OF NONFERROUS MATERIALS WITH DIAMOND TOOLS

GLASS GRINDING

Diamond tools are used for glass grinding in a wide range of industries, including technical sheet glass processing, auto- mobile glass, optical glass, crystal and glassware.

Diamond wheels with semicircular and trapezoidal profiles, as well as with other profiles, are used for grinding glass surfaces. As a rule, diamond wheels that are electroplated and with metal bonds are used for glass surface grinding. The wheels are made with diamond powder types AC6-AC32 (synthetic diamonds) grit size D213 D64 with electroplating (nickel) or with metal bonds types M2-01, M3-04, M-300, M3-08.

For minimum wear of the diamond layer, diamond wheels should be balanced after being mounted on the spindle. It is not recommended to take the diamond wheels off the flange until they are fully used. Truing and dressing are necessary to restore the profile and the cutting properties of the wheels. Dressing is performed with a silicon carbide grinding wheel or electrolytes.

For automobile glass surfaces, the following parameters for diamond grinding are recommended:

Grinding speed, m/sec.....25-30;
Glass feeding speed, m/min.....3,5-5,5;
Wheel pressing strength, H.....0,35-0,50;
Coolant usage (water based) is 10-15 l/min;
Tolerances.....0,2-0,3mm;

During the use of the wheel, its cutting properties become weaker, so it is necessary to increase the wheel pressure on the glass. If chips appear on the edge of the glass, the wheel must be dressed.

CRYSTAL GLASS PROCESSING

Diamond tools are widely used in the manufacture of crystal and glassware: edge grinding, grinding of flat surfaces and bases (wine glasses, etc.), sharp edge blunting (facet grinding), engraving, grinding of conical surfaces. For such purposes diamond grinding wheels 14EE1, 1EE1 with metal bonds are used.

The wheel size and type are chosen depending on the operation and the shape and size of the item to be machined. As a rule, medium sized and large items are processed on machines individually, small parts are processed on automatic machines with programmed designs.

Characteristics of diamond layers for decorative glass processing

Processing type	Workpiece	Diamond powder characteristics	
		Grade	Diamond concentration, %
Edge grinding with width up to 5 mm	Small and medium	D54	50
Edge grinding with width more than 5 mm	Medium	D64	
Edge pregrinding with width more than 8 mm	Medium and Large	D213 D181 D107	100
Edge finishing with width more than 8 mm	Medium	D54	50
	Large	D64 M40	50; 100
Engraving, cone engraving, fine faceting, drawing	Small	D54	50
	Medium	M63	
	Large	M40	

CRYSTAL GLASS PROCESSING (continuation)

To prepare the grinding wheel for usage is of great importance. It is to be checked thoroughly after storage: cracks, diamond layer peeling, and nicks are not acceptable. The wheel must be balanced after mounting on the flange, and after its placement on the spindle the wheel must be adjusted to avoid wear of the diamond layer.

The wheel profile angle as a rule is 90°, 110°, 130° or 140°. The characteristics of diamond wheels recommended for decorative and household glass are found in the table.

The articles have been divided into the following sizes:

Large vases with height more than 250 mm, diameter 150 mm, decanters with capacity more than 500 ml, Medium vases with height up to 250 mm, diameter 150 mm, decanters with capacity up to 500 ml, Small wineglasses, glasses, salt shakers, etc.. During hand drawing operations, water based coolant is always used in order to visually monitor the process. Mineral oil coolant as well as water coolant are used in machine drawing operations.

DIAMOND DRILLS

Diamond drilling is the most productive method of making a hole in friable, hard, nonmetallic materials. The most commonly used in industry are tubular drills consisting of a diamond rim crown, fixed in a cylindrical core (drill end). These tools remove material only on the rim surface. Usage of drills of this type helps to reduce axial load and to ease coolant supply to the cutting area. It provides high productivity and quality of processing and decreases diamond use.

Recommended rotational speed of drills for glass drilling

Drill diameter, mm	Rotational speed, RPM	Mechanical feeding, mm/min
1 - 3	6 000 - 24 000	20 - 50
3 - 6	3 000 - 12 000	30 - 60
6 - 15	2 600 - 6 000	30 - 50
15 - 25	2 000 - 4 500	25 - 40
25 - 50	1 200 - 2 500	20 - 30
50 - 100	500 - 1 200	10 - 20

In other types of drilling, the coolant is supplied to the work area though a tube inside the tool. As a rule, for the hand drilling of furniture, mirror and automobile glass, industrial water is used.

The pressure of the coolant is normally determined by the drill diameter:

Drill diameter, mm	1 - 5	6 - 10	11 - 20	21 - 40	41 - 100
Coolant pressure, MPa	0,3 - 0,5	0,2 - 0,4	0,15 - 0,25	0,05 - 0,15	0,2 - 0,1

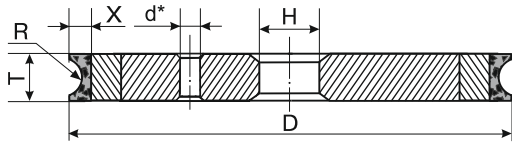

DIAMOND WHEELS FOR GLASS PROCESSING

1F6V

1F6V D*T*X*W*R*H

(A-LINE EDGE) (STANDARD LINE)

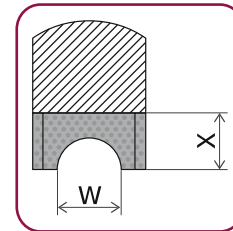

Picture 1

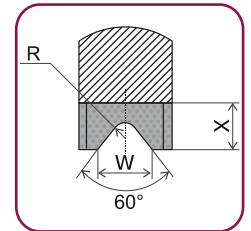

Picture 2

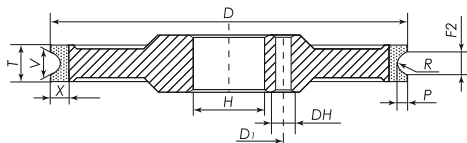

14F6V D*T*U*X*R*W*H

DIAMOND WHEELS

14F6V

(STANDARD LINE)

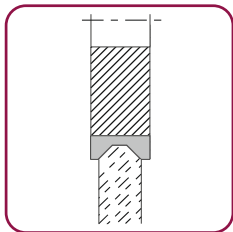

Machining of technical
glass edge



d*- at D=150,
2 apertures $\varnothing 7,0 \times 180^\circ$ by $\varnothing 70$

d*- at D=175,
3 apertures $\varnothing 8,5 \times 120^\circ$ by $\varnothing 76$

- Processing of technical glass and mirrors.
- Diamond layer is made of diamond grinding powders and micro grinding powders with metal bonds.
- Coolant is required.

Glass thickness, mm	Wheel form	Picture	Code	D, mm	T, mm	U, mm	X, mm	R, mm	W, mm	H, mm
2	1F6V	1	150-02	150	10	-	5	1,4	2,7	22
3	1F6V	2	150-03	150	12	-	8	1,6	4,2	22
4	1F6V	2	150-04	150	12	-	8	2,0	4,6	22
5	1F6V	2	150-05	150	12	-	8	2,5	5,8	22
6	1F6V	2	150-06	150	12	-	8	4,0	8,1	22
8	1F6V	1	150-08	150	18	-	9	5,5	11,0	22
10	1F6V	1	150-10	150	18	-	8	8,6	12,1	22
2	14F6V	1	175-02	175	12	11	7	1,4	2,7	63,4
3	1F6V	2	175-03	175	12	-	7	1,6	4,2	63,4
4	1F6V	1	175-04	175	12	-	8	2,5	5,0	63,4
5	1F6V	2	175-05	175	12	-	8	2,5	5,8	63,4
6	14F6V	2	175-06	175	14	12	8	4,0	7,5	63,4
8	14F6V	1	175-08	175	17	12	8	5,5	10,0	63,4

Customer-specific and other grinding tools can be produced on request.

DIAMOND FLAT GRINDING WHEELS WITH SEMICIRCULAR-CONCAVE PROFILE FOR MACHINES BY: SULAK, INTERMAC, Z.BAVELLONI, SZILANK, ETC.

1F6V DIAMOND WHEELS FOR GLASS PROCESSING

(A-LINE EDGE) (PREMIUM LINE)

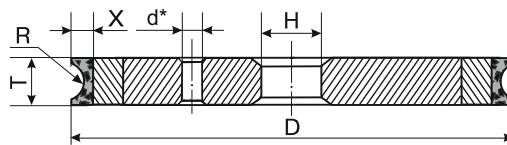

1F6V D*T*X*W*R*H

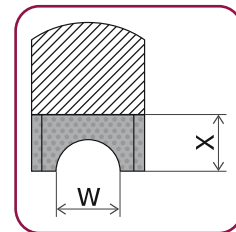

Glass thickness, mm	Code	D, mm	T, mm	X, mm	R, mm	W, mm	H, mm
2	FL-310	150	7	6	1,8	3,2	22
3	FL-311	150	8	6	2,25	4,2	22
4	FL-312	150	9	6	2,7	5,2	22
2	FS-310	150	7	6	1,8	3,2	22
3	FS-311	150	8	6	2,25	4,2	22
4	FS-312	150	9	6	5,2	5,2	22

Customer-specific and other grinding tools can be produced on request.

1DD6V DIAMOND WHEELS FOR GLASS PROCESSING

(A-LINE EDGE) (PREMIUM LINE)

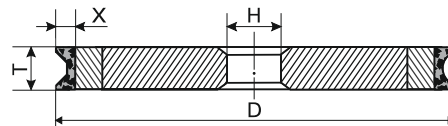

1DD6V D*T*X*f*W*H

- Processing of technical glass edges and mirrors on machines by Sulak, Intermac, Z.Baveloni, Szilank, etc.
- Diamond layer is made of diamond grinding powders with metal bonds.
- Coolant is required.

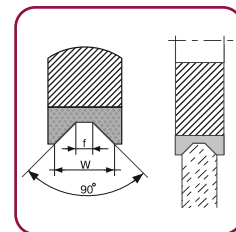
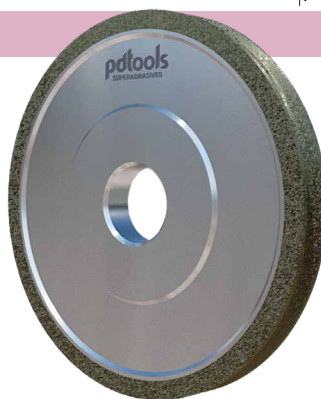

Machining of technical glass edges

Glass thickness, mm	Code	D, mm	T, mm	X, mm	f, mm	W, mm	H, mm
4	DL-311	150	8	7	2,5	5	22
5	DL-312	150	9	7	3,3	6	22
6	DL-313	150	10	7	4	7	22
8	DL-314	150	12	7	5,3	9	22
10	DL-315	150	14	7	7,5	11	22
12	DL-316	150	16	7	9,5	13	22
4	DS-311	150	8	7	2,5	5	22
5	DS-312	150	9	7	3,3	6	22

Customer-specific and other grinding tools can be produced on request.

DIAMOND RING WHEELS 2A2

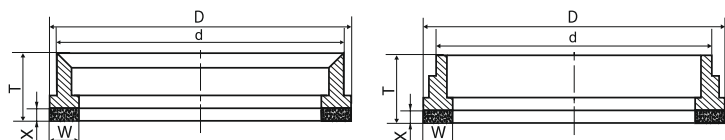

2A2 D*T*W*X*d

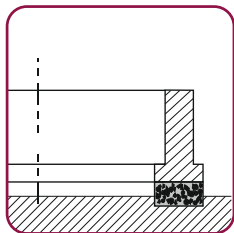

Hole drilling



- Grinding of spherical and flat surfaces made of non-metal hard materials (glass, silicon).
- Production of tube drills with diameters more than 20 mm.
- The diamond layer is made of diamond grinding powder and micropowders with metal bonds.
- Usage of coolant is obligatory.

Catalog number	Picture	D, mm	T, mm	W, mm	X, mm	d, mm
6-0100	1	30	32	5	10	30
6-0101	1	35	32	5	10	25
6-0102	1	40	32	5	10	30
6-0103	1	60	32	5	10	50
6-0104	1	50	32	5	10	40
6-0105	1	70	32	5	10	60
6-0106	1	80	32	5	10	70
6-0107	2	50	31	2,5	8	47
6-0108	2	60	31	2,5	8	57
6-0109	2	70	31	2,5	8	67
6-0110	2	80	31	2,5	8	77

Customer-specific and other grinding tools can be produced on request.

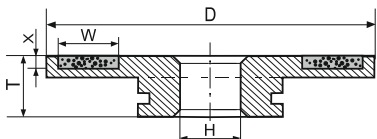

1A2 D*T*W*X*H

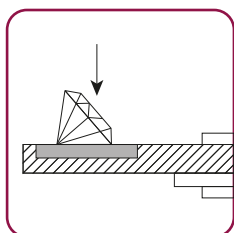

Diamond faceting



FLAT DIAMOND GRINDING WHEELS 1A2

- Processing of diamonds, precious and semiprecious stones, decorative stones.
- Made with axis and without.
- The diamond layer is made of diamond grinding powder and micropowders with metal bonds.

Catalog number	D, mm	T, mm	W, mm	X, mm	H, mm
9-3050	270	22	30	2	50
9-3033	320	16	30	1,5	114
9-3034	315	22	30	1,5	114
9-3038	315	16	30	2	114
9-3035	315	22	40	1,5	114
9-3036	315	10,5	60	1,5	114
9-3037	315	22	40	1,5	50,8
9-3045	315	22	60	1,5	50,8
9-3042	315	44	60	2	30

Customer-specific and other grinding tools can be produced on request.

2F6V FLAT DIAMOND GRINDING WHEELS

WITH SEMICIRCULAR-CONCAVE PROFILE

STANDARD LINE

- Machining of edges of industrial glass.
- The diamond layer is made of diamond grinding powder and micropowders with metal bonds.
- Usage of coolant is obligatory.

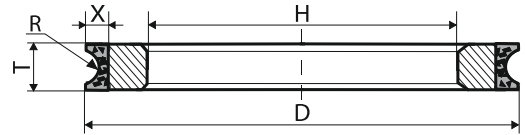

2F6V D*T*X*R*W*H

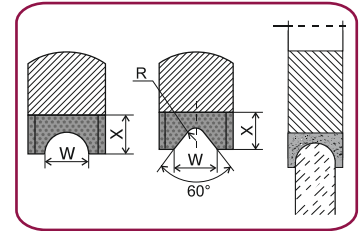

Machining of edges of industrial glass

Glass thickness, mm	Code	Picture	D, mm	T, mm	X, mm	R, mm	W, mm	H, mm
3	9-0121	2	200	20	8,0	2,0	4,2	130
2	9-0112	1	250	9	7,0	1,6	3,2	200
3	9-0113	1	250	9	7,0	1,8	3,6	200
3	9-0114	1	250	9	7,0	2,0	4,0	200
3	9-0117	2	250	10	6,0	1,6	4,0	200
4	9-0115	1	250	12	7,0	2,5	5,0	200
5	9-0101	1	250	12	7,0	3,0	6,0	200
6	9-0116	1	250	17	7,0	4,0	8,0	200
8	9-0103	1	250	17	9,0	5,0	10,0	200

Customer-specific and other grinding tools can be produced on request.

1DD6V DIAMOND WHEELS FOR GLASS PROCESSING

(STANDARD LINE)

- Processing of technical glass edges and mirrors on machines by Sulak, Intermac, Z.Baveloni, Szilank, etc.
- Diamond layer is made of diamond grinding powders with metal bonds.
- Coolant is required.

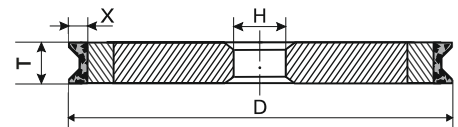

1DD6V D*T*X*f*W*H

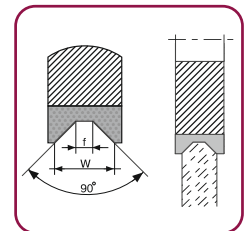

Machining of technical glass edges

Glass thickness, mm	Code	D, mm	T, mm	X, mm	f, mm	W, mm	H, mm
4	150T04	150	14	4,5	2,5	6,5	22
5	150T05	150	14	4,5	3,0	7,0	22
6	150T06	150	14	4,5	3,5	7,5	22
8	150T08	150	16	4,5	5,0	9,0	22
10	150T10	150	16	4,5	7,0	11,0	22

Customer-specific and other grinding tools can be produced on request.

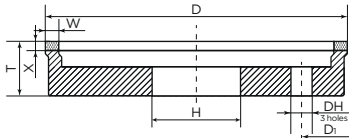

FLAT RECESSED DIAMOND GRINDING WHEELS **6A2**

6A2 D*T*W*X*H

(PREMIUM LINE AND STANDARD)

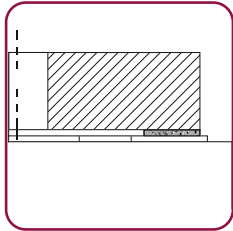

Surface grinding



- Processing of technical glass edges and.
- Diamond layer is made of diamond grinding powders with metal bonds.
- Coolant is required.

Code	D, mm	T, mm	W, mm	X, mm	H, mm
3-2912	160	51	12	8	130
3-2870	150	40	8	8	30
3-2871	160	51	8	8	130
3-2868	150	42	5	8	40
3-2914	150	26	6	6	50
3-2932	100	23	15	6	40
3-3046	150	30	8	8	50

Customer-specific and other grinding tools can be produced on request.

1EE1 FLAT DIAMOND GRINDING WHEELS

WITH DOUBLE-SIDED CONICAL PROFILE

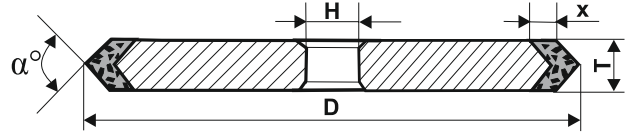

1EE1 D*T*X* α *H

14EE1 FLAT DIAMOND GRINDING WHEELS

WITH DOUBLE-SIDED CONICAL PROFILE

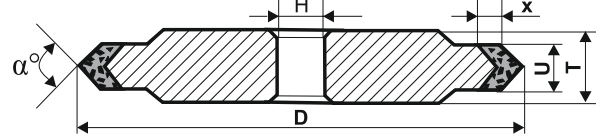

14EE1 D*T*X* α *H

- Processing of industrial and decorative glass, crystal, external threading and grinding.
- Grinding of profiled workpieces made of carbide and other hard to process materials.
- The diamond layer is made of diamond grinding powder and micropowders with metal or resin bonds.
- For metal bonded tools coolant is required.

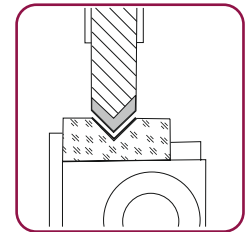

Glass cutting

Type 1EE1

Catalog number	D, mm	T, mm	X, mm	α°	H, mm
9-0616	30	4	2,5	30	6
7-1175	50	10	5	90	16
9-0035	50	10	5	120	16
7-0186	75	16	5	110	32
9-0618	80	10	10	120	32
7-1240	100	10	10	90	42
7-1246	100	10	10	120	42
7-0190	150	8	5	90	32
7-0191	150	8	5	110	32
7-0274	150	10	5	120	42
9-0539	150	10	10	90	32
9-0531	150	10	10	120	42
7-0193	150	12	5	90	32
7-0197	150	12	10	110	32
7-0303	150	12	10	110	42
7-0196	150	12	10	90	32
7-0200	150	16	5	110	32
7-0203	150	16	10	110	32
9-0034	200	10	10	90	42
9-0540	200	10	10	120	42
7-0210	250	10	10	110	32
7-0215	250	12	10	110	32
7-0216	250	16	5	90	32
7-0217	250	16	5	110	32

Customer-specific and other grinding tools can be produced on request.

Type 14EE1

Catalog number	D, mm	T, mm	U, mm	X, mm	α°	H, mm
9-3229	125	6	3	3	90	32
9-3133	125	6	3	4	60	32
9-3204	125	6	3	5	45	32
9-3203	125	6	3	6	35	32
7-0154	250	10	6	5	110	32
7-0158	250	10	8	5	110	32

Customer-specific and other grinding tools can be produced on request.

DIAMOND DRILLS

Application:

- Drilling of holes in optical and industrial glass and other non-metal materials
- Diamond layer is made of diamond powders and micropowders with electroplated bonds
- Usage of coolant is obligatory.

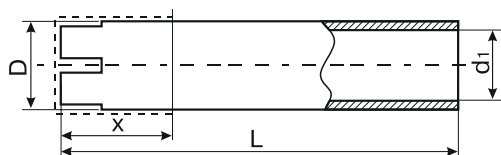

Picture 1

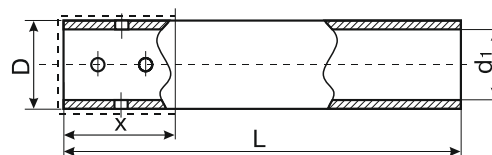

Picture 2

Designation of drill size and type	Core	Picture	D, mm	d ₁ , mm	L, mm	X, mm
04.01.159.00	Brass	1	3	2,5	57	6
04.01.159.00-01		1	4	3,5	57	6
04.01.159.00-02		1	5	4,5	57	6
04.01.159.00-03		1	6	5	57	6
04.01.159.00-04		1	7	6	57	6
04.01.159.00-05		1	8	7	57	6
04.01.159.00-06		1	9	8	57	6
04.01.159.00-07		1	10	9	57	6
04.01.159.00-08		1	12	10	57	6
04.01.159.00-09		1	14	12,8	57	6
04.01.159.00-10	1	16	14,8	57	6	
04.01.242.00	Steel	1	3	1,4	50	6
04.01.242.00-01		1	4	2,4	50	6
04.01.242.00-02		1	5	3,4	50	6
04.01.242.00-03		1	6	4,4	50	6
04.01.242.00-04		1	7	5	50	6
04.01.242.00-05		1	8	6	50	6
04.01.242.00-06		1	9	7	50	6
04.01.242.00-07		1	10	8	50	6
04.01.242.00-08		1	12	10	50	6
04.01.242.00-09		1	14	12	50	6
04.01.242.00-10		1	16	14	50	6
04.01.242.00-11		1	14,6	13	60	6
04.01.242.00-12		1	19,6	17,6	60	8
04.01.242.00-13	1	18	15,6	60	8	
06.02.002.00	Steel	2	3	2,5	57	8
06.02.002.00-01		2	4	3,5	57	8
06.02.002.00-02		2	5	4,5	57	8

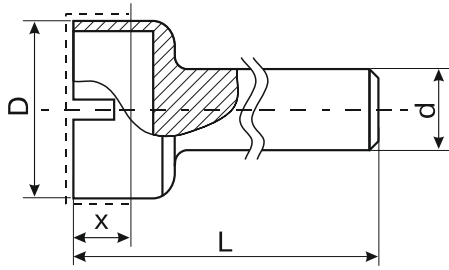

Picture 3

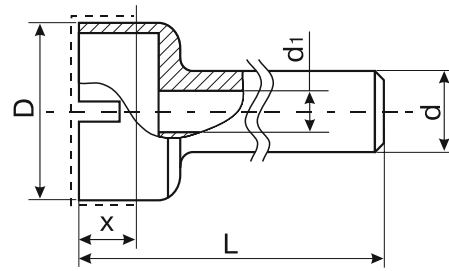

Picture 4

Designation of drill size and type	Picture	D, mm	d, mm	d ₁ , mm	L, mm	X, mm
06.02.001.00	3	65	9,5	-	60	10
06.03.001.00	4	19	9,5	4	70	7
06.03.001.00-30	4	10	9,5	4	70	8
06.03.001.00-31	4	12	9,5	4	70	8
06.03.001.00-32	4	14	9,5	4	70	8
06.03.001.00-33	4	16	9,5	4	70	8
06.03.001.00-34	4	20	9,5	4	70	8
06.03.001.00-36	4	17	9,5	4	70	14
06.03.001.00-04	4	26	9,5	4	70	8
06.03.001.00-08	4	22	9,5	4	70	8
06.03.001.00-09	4	24	9,5	4	70	8
06.03.001.00-13	4	25	9,5	4	70	8
06.03.001.00-14	4	27	9,5	4	70	8
06.03.001.00-05	4	30	6	4	50	8
06.03.001.00-46	4	32	9,5	4	70	8
06.03.001.00-24	4	35	9,5	4	70	8
06.03.001.00-35	4	36	9,5	4	70	8
06.03.001.00-40	4	40	9,5	4	70	14
06.03.001.00-16	4	50	9,5	4	60	10
06.03.001.00-49	4	60	9,5	4	50	10
06.03.001.00-17	4	70	9,5	4	50	10
06.03.001.00-12	4	80	9,5	4	60	10
06.03.001.00-01	4	81	9,5	4	60	10
06.03.001.00-02	4	86	9,5	4	50	10
06.03.001.00-48	4	120	9,5	4	60	10
06.03.005.00	4	12	9,5	4	70	8
06.03.005.00-01	4	14	9,5	4	70	8
06.03.005.00-02	4	16	9,5	4	70	8
06.03.005.00-03	4	26	9,5	4	70	8
06.03.005.00-04	4	30	9,5	4	70	8
06.03.005.00-05	4	35	9,5	4	70	8
06.03.005.00-06	4	55	9,5	4	70	8
06.03.005.00-07	4	75	9,5	4	70	10
06.03.005.00-08	4	90	9,5	4	70	10
06.03.005.00-09	4	40	9,5	4	65	10
06.03.006.00	4	78	28	M14	81	10

Customer-specific and other grinding tools can be produced on request.

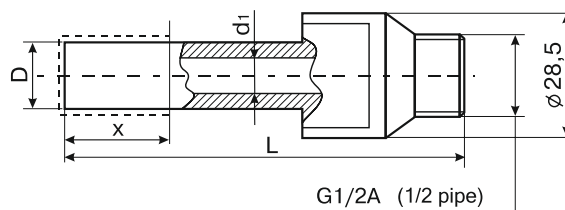

Picture 5

Designation of drill size and type	Picture	D, mm	d ₁ , mm	L, mm	X, mm
06.04.001.00	5	12	8	75	10
06.04.001.00-01	5	12,5	8	75	10
06.04.001.00-02	5	13	8	75	10
06.04.001.00-03	5	13,5	8	75	10
06.04.001.00-04	5	14	8	75	10
06.04.001.00-05	5	14,5	8	75	10
06.04.001.00-06	5	15	8	75	10
06.04.001.00-07	5	15,5	8	75	10
06.04.001.00-09	5	16	8	75	10
06.04.001.00-11	5	16,5	8	75	10
06.04.001.00-12	5	17	8	75	10
06.04.001.00-13	5	17,5	8	75	10
06.04.001.00-14	5	18	8	75	10
06.04.001.00-15	5	18,5	8	75	10
06.04.001.00-16	5	19	8	75	10
06.04.001.00-17	5	19,5	8	75	10
06.04.001.00-18	5	20	8	75	10
06.04.001.00-19	5	21	8	75	10
06.04.001.00-22	5	22	8	75	10
06.04.001.00-24	5	23	8	75	10
06.04.001.00-26	5	24	8	75	10
06.04.001.00-27	5	40	8	75	10
06.04.001.00-28	5	50	8	75	10
06.04.001.00-30	5	51	8	75	10
06.04.001.00-31	5	52	8	75	10
06.04.001.00-32	5	54	8	75	10
06.04.001.00-33	5	55	8	75	10
06.04.001.00-34	5	3	8	75	10
06.04.001.00-35	5	6	8	75	10
06.04.001.00-36	5	10	8	75	10
06.04.001.00-37	5	30	8	75	10
06.04.001.00-38	5	70	8	75	10
06.04.001.00-39	5	100	8	75	10
06.04.001.00-40	5	5	3,5	75	5

Customer-specific and other grinding tools can be produced on request.

pdtools
SUPERABRASIVES



DIAMOND DRESSING ROLLERS

DIAMOND PROFILE DRESSING ROLLERS

Diamond profile dressing rollers are an integral part of modern grinding technology and are mainly used in serial and mass production. Diamond rollers are used for dressing of abrasive wheels.

With the help of diamond rollers, a copy of the profile of the required part is created on the surface of the working abrasive wheel. Then the abrasive wheel transfers this profile to the workpiece.

At the same time, diamond rollers allow to combine several processing transitions at once, including turning, milling and preliminary grinding.

The production program of **PDTools Superabrasives** includes the production of diamond rollers which are used for:

- crankshaft processing;
- processing of ball pins;
- grinding of piston rings;
- valve handling: -manufacturing of turbine blades;
- manufacturing of cogwheels; - manufacturing of threaded connections;
- manufacturing of details of the bearing industry.

Advantages in application of diamond profile dressing rollers:

- creation of the abrasive wheel's surface within minimum possible time;
- profiling the surface of the abrasive wheel in one operation;
- high accuracy even during the creation of very complex profiles.

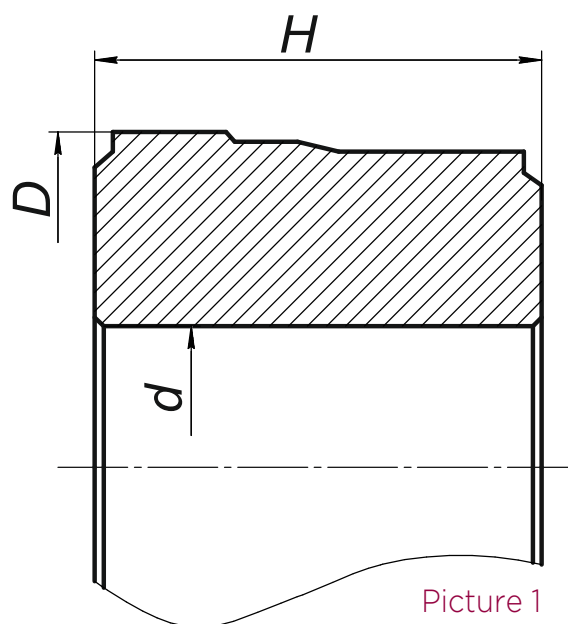
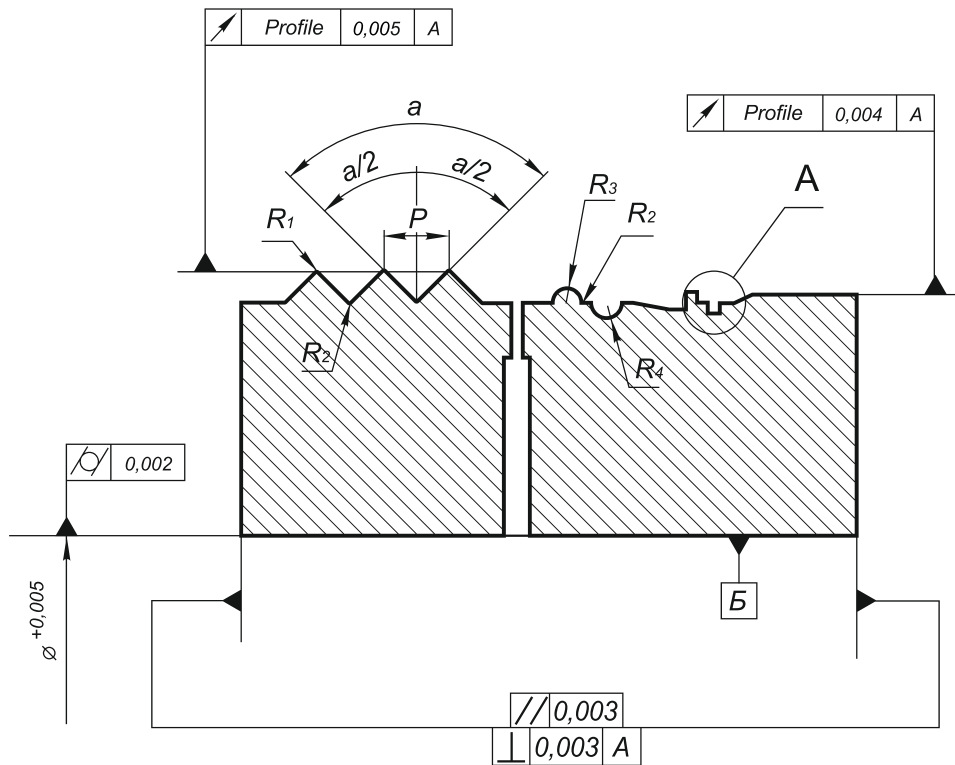

Table 1

Dimensions	Diamond roller Dimensions, mm O2H*
D max	160
D min	65
H max	140
H min	10
d min	20

***O2H** - the method of electroforming with a non-orientable arrangement of diamonds bonded with a metal bond. The ratio of the diameter of the diamond roller to its height should be no more than 0.9.

Minimum tolerances for the shape and arrangement of diamond roller surfaces



Picture 2

A

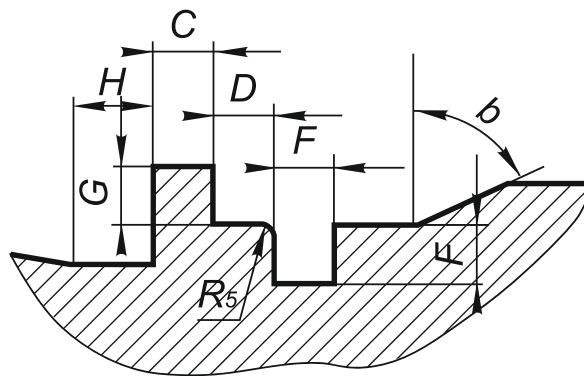

Table 2

$C = \pm 0,002$	$H = \pm 0,002$	$R_4 = 0,01$
$D = \pm 0,002$	$P = \pm 0,002$	$R_5 = 0,012$
$E = \pm 0,002$	$R_1 = 0,15$	$a = \pm 3'$
$F = \pm 0,002$	$R_2 = \pm 0,12$	$a/2 = \pm 3'$
$G = \pm 0,002$	$R_3 = \pm 0,01$	$b = \pm 3'$

Each roller is accompanied by a measurement protocol that meets the customer's requirements, as well as a control sample of the roll profile.

Allowable diamond grain sizes **Min 250/200 Max 1000/800**.

Attention:

PDTools Superabrasives also produces other shapes and types of diamond rollers.

pdtools
SUPERABRASIVES

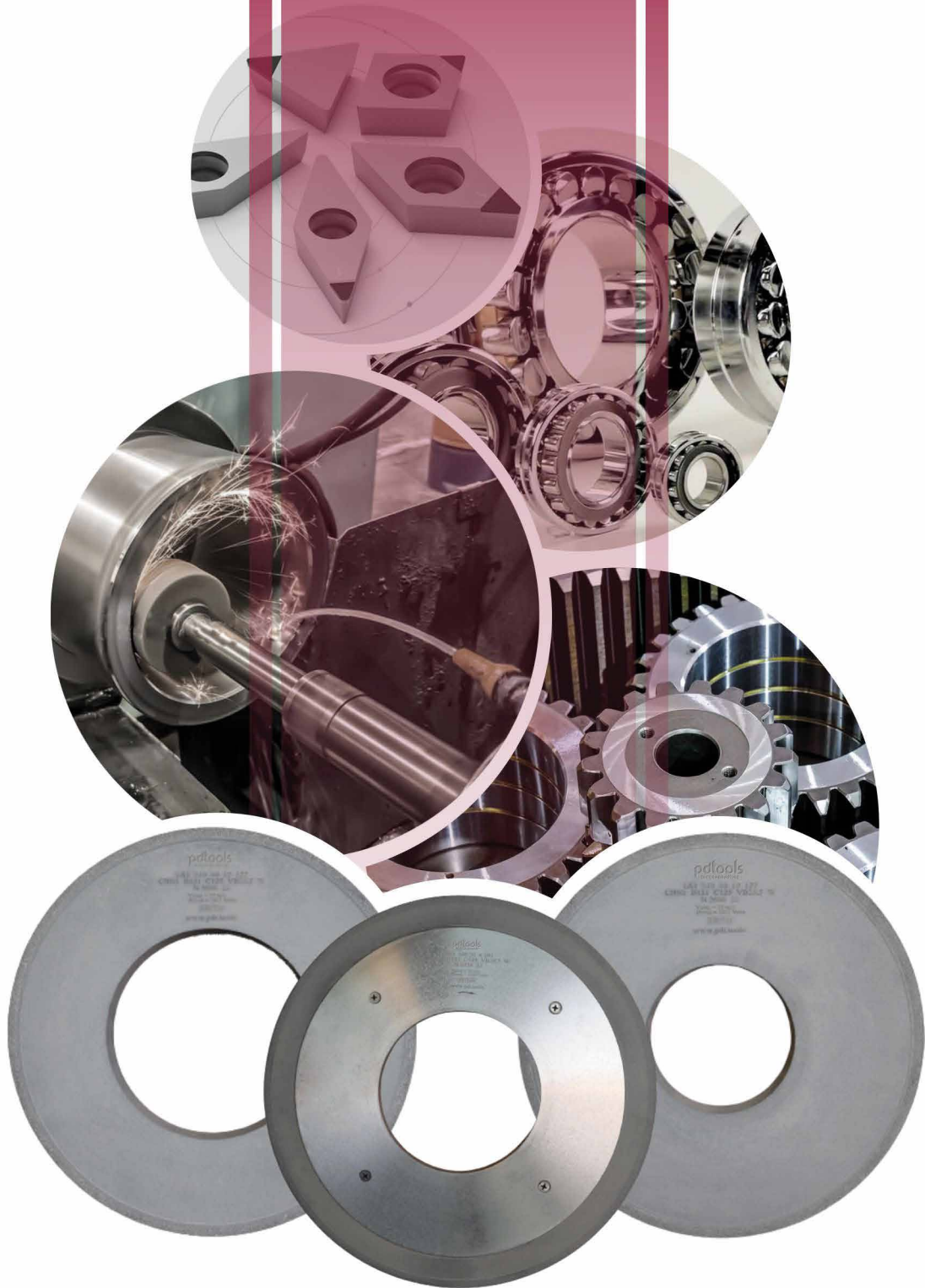

VITRIFIED BONDED CBN GRINDING WHEELS

VITRIFIED BONDED CBN GRINDING WHEELS

The Application Area

- cylindrical grinding, flat grinding, internal grinding operations
- producing of details for bearing industry etc.
- sharpening of metal cutting tools
- gear grinding operations
- thread-grinding operations
- producing parts for turbine etc.

Main Processed Materials

- instrument steel (P18, P6M5 etc.)
- bearing steel
- titanium alloy
- heat-resistant steel
- alloy-therated steel



Recommendations for Wheel's Hardness Selection

Table 1. Types of hardness

Group of Hardness	Designation in accordance with ISO Standards
Soft	J
	K
	L
Medium-soft	M
	N
	O
Hard	P
	Q
	R
	S

Main Rules for Vitrified Bonded Grinding Wheels Hardness Selection

1. Grinding of hard materials - soft bond. The soft bond also could be used for grinding of soft and yielding materials, such as heatproof and nonferrous alloys.
2. For rough grinding should be used wheels with harder bond.
3. In case of speed rising client should decrease the hardness of the bond.
4. In case of large contact of grinding wheel with processed surface should be used softer bond.



VBA05 - normal porosity

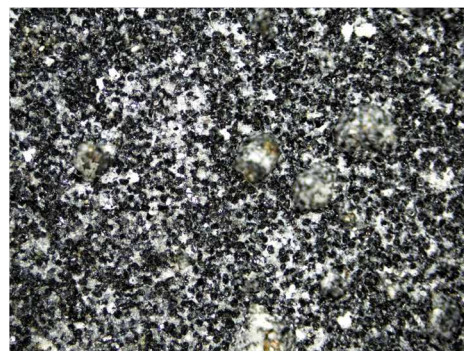

VBB05 - extended porosity

GRIT AND BOND HARDNESS RECOMMENDATIONS FOR VITRIFIED BONDED WHEELS

Grinding method	Grit size	Hardness
Surface grinding: Peripheral grinding, Ra 0,32 - 1,25 Face grinding, Ra 0,16 - 0,63	B91 ... B126 B54 ... B76	L - M K - L
Internal grinding:	B64 ... B126	O - R
Cylindrical grinding: In-feed grinding, Ra 0,32 - 1,25 Traverse grinding Ra 0,16 - 0,63	B126 ... B151 B54 ... B107	N - O M - N
Gear grinding: Module < 3 mm Module > 3 mm	B76 ... B91 B107 ... B151	L - N K - M
Thread grinding: Pitch of thread 0,5 - 0,8 mm Pitch of thread 0,8 - 1 mm Pitch of thread 1 - 1,5 mm Pitch of thread > 1,5 mm	B16 ... 825 B25 ... B40 B40 ... B54 B54 ... B76	P - S O - P M - N L - N

Characteristic of vitrified bonds PDTools Superabrasives

Vitrified bonds	Hardness	Edge-resistance	Porosity	Recommendation for material hardness <small>(recommendations are conditional and depend on the kind of the processed material)</small>
XBCK4	K	high	low	more than 55HRC
XBCL4	L			
VBCN5	N	high	low	less than 55HRC
VBCM5	M			
VBCO5	O	high	low	less than 55HRC
VBCP5	P			
VBBO5	O	low	high	less than 60HRC
VBBP5	P			

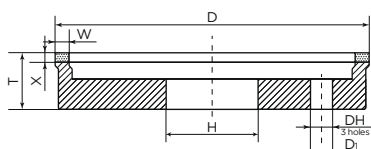

FLAT RECESSED DIAMOND GRINDING WHEELS **6A2**

(PREMIUM LINE AND STANDART)

6A2 D*W*X*T*H

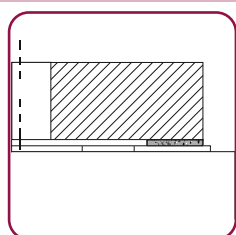

Surface grinding



- Grinding wheels are used for surface, cylindrical, face grinding of forged, cemented, bearing, heat-resistant, tool, alloyed, high-speed steels etc.

Code	D, mm	W, mm	X, mm	T, mm	H, mm
K-0062	100	15	10	40	20
K-0064	100	15	10	40	40
K-0067	125	5	10	40	40
K-0001	150	20	10	40	40
K-0033	150	20	10	40	40
K-0051	150	15	10	40	40

Customer-specific and other grinding tools can be produced on request.

1A1 STRAIGHT GRINDING WHEELS

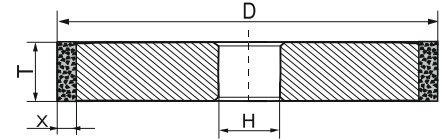

1A1 D*T*X*H

- Grinding wheels are used for surface, cylindrical, ID and centerless grinding of forged, cemented, bearing, heat-resistant, tool, alloyed, high-speed steels etc.

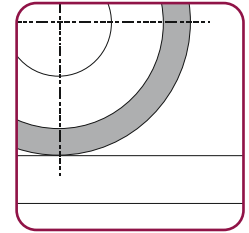

Flat surface grinding

Catalog number	D, mm	T, mm	X, mm	H, mm
K-0085	125	10	5	32
K-0124	20	30	5	10
K-0125	30	30	5	10
K-0126	32	20	5	10
K-0123	20	30	3	10
K-0127	35	32	5	10
K-0129	40	20	5	10
K-0130	40	32	5	20
K-0115	50	40	5	20
KD0119	60	50	5	32
K-0118	60	40	5	20
K-0117	60	32	5	20
K-0116	60	20	5	32
KB0085	125	4	5	32
KB0148	100	20	5	32
K-0120	70	20	5	20
K-0068	125	20	5	32
KG0055	150	20	5	32
K-0055	150	10	5	32
KD0004	200	8	5	32
K-0004	200	10	5	32
KB0036	200	10	10	32
K-0002	200	20	5	32
KL0036	200	20	10	32
KJ0011	250	20	10	76
KL0011	250	25	10	76
KD0011	250	16	10	76
K-0011	250	20	5	76
KB0003	300	13	5	127
K-0318	300	20	10	127
K-0320	300	40	10	127
K-0013	350	20	5	127
K-0319	350	20	10	127
K-0321	350	40	10	127
K-0199	400	20	10	203
K-0198	400	20	10	127
K-0200	400	40	10	203
K-0200	400	40	10	127
K-0203	450	40	5	127
K-0205	500	50	6	203

Customer-specific and other grinding tools can be produced on request.

STRAIGHT FLAT GRINDING DIAMOND WHEELS

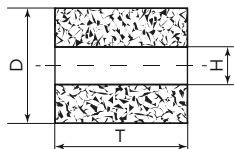

A8 D*T*H

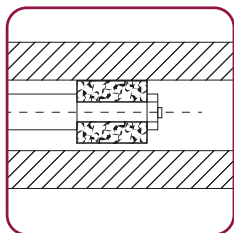

Internal grinding



- Grinding wheels are used for internal (ID) grinding of forged, cemented, bearing, heat-resistant, tool, alloyed, high-speed steels etc.

Catalog number	D, mm	T, mm	H, mm
K-0185	10	10	4
KD0185	10	14	4
KB0192	12	18	4
KG1791	15	20	5
KB1791	15	25	5
KD0223	18	20	6
KB0113	25	30	6
K-0121	12	20	5
KG0192	12	16	4
KB0038	10	18	3
KB0023	6	10	3
K-0255	4	10	1,6
K-0256	5	10	2,6
K-0257	6	10	2,6
KB0022	8	14	3
K-0038	10	10	3
K-0039	15	10	4
K-0122	15	18	4
K-0223	20	20	6
K-0195	20	20	8
K-0007	25	20	10
K-0132	30	30	10
K-0128	35	35	10
KB0025	40	40	10
K-0131	60	32	20

Customer-specific and other grinding tools can be produced on request.

1E6Q GRINDING WHEELS

- Grinding wheels are used for grinding of metric, pipe, trapezoidal (tapered), buttress threads of different hard steels etc.

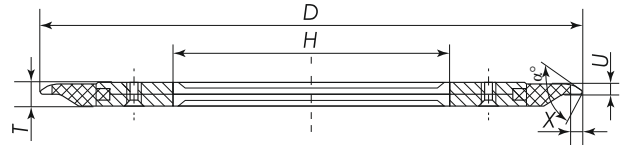

1E6Q D*T*U*X*α*H

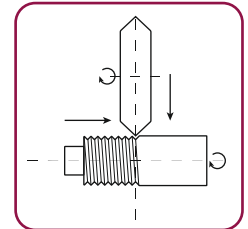

Surface grinding

Code	D, mm	T, mm	U, mm	X, mm	α°	H, mm
K-0014	400	14	10	4	40	203
K-0015	400	14	10	4	60	203
K-0016	400	14	10	4	90	203
K-0017	400	14	10	6	40	203
K-0018	400	14	10	6	60	203
K-0019	400	14	10	6	90	203

Customer-specific and other grinding tools can be produced on request.

AW CYLINDRICAL DIAMOND POINTS

- Grinding of cylindrical surfaces.
- The diamond layer is made of diamond grinding powder and micropowders with metal or resin bonds.
- For metal bonded tools coolant is required.
- Hollow teeth grinding.
- Inner diameter grinding of hard metal, HSS and nonmetal workpieces.

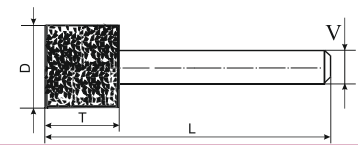

AW D*T*V*L

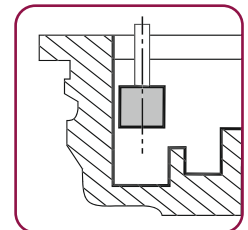

Internal grinding

Catalog number	D, mm	T, mm	V, mm	L, mm
K-0322	4	10	1,6	50
K-0323	5	10	2,6	50
K-0324	6	10	2,6	50

Customer-specific and other grinding tools can be produced on request.